

8 Hints
for Making Better Measurements Using
RF Signal Generators
Application Note

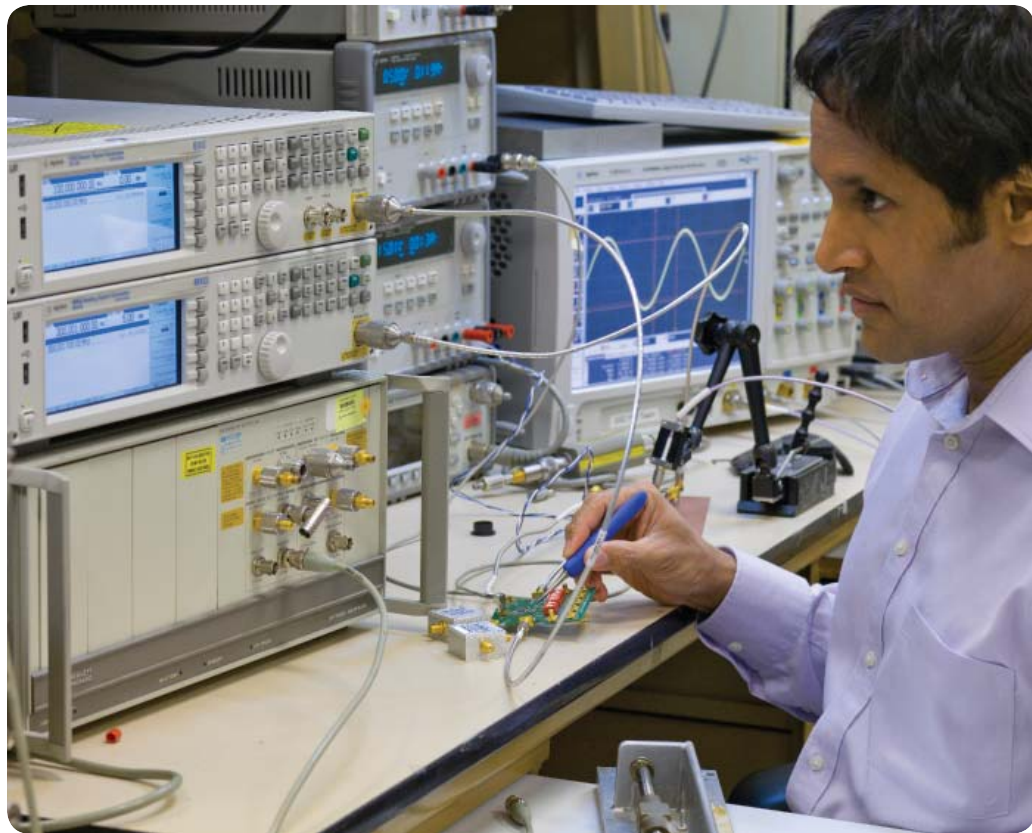

Signal sources provide precise, highly stable test signals for a variety of component and system test applications. Signal generators add precision modulation capabilities, and are used to simulate system signals for receiver performance testing.

This guide helps you improve the accuracy of your measurements that involve using RF signal sources. You may increase the accuracy of your data by using more than one of the hints in your test setup.

HINT 1.
Improve source’s effective harmonic distortion

Use a low pass filter at the output of your source to decrease its harmonic distortion.

HINT 2.
Increase power level accuracy

Use a power meter to increase the accuracy of the signal level at your device under test (DUT).

HINT 3.
Improve frequency accuracy

Select the appropriate frequency reference to improve absolute or relative frequency accuracy.

HINT 4.
Improve source match

Use a fixed attenuator to reduce the mismatch error.

HINT 5.
Combine source outputs for TOI measurements

Use a proper setup to isolate sources, improve match. I/Q modulator

HINT 6.
Extend the amplitude range

Use an amplifier or an attenuator to increase or decrease respectively, the amplitude range of your signal source.

HINT 7.
Optimizing for EVM and ACLR for LTE component testing

Use appropriate filtering to optimize for EVM and ACLR.

HINT 8.
Select the optimum phase noise profile

Choose the appropriate phase noise profile to optimize in-channel or out-of-channel measurements.

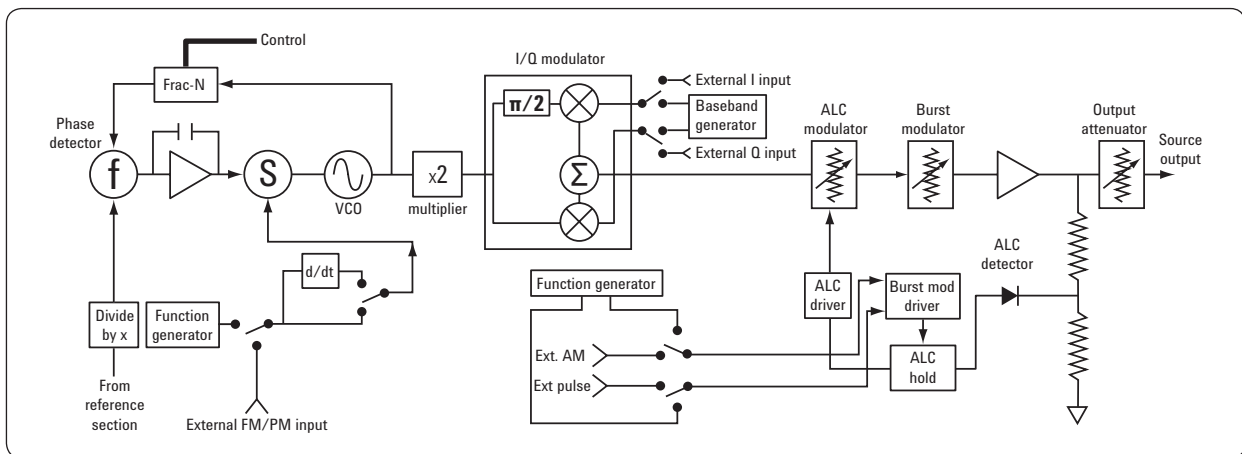

Typical vector signal generator block diagram.

HINT 1.

Improve source's effective harmonic distortion

Accurate harmonic distortion measurements require a spectrally pure signal source and a spectrum analyzer. The harmonic distortion of the signal source and the dynamic range of the spectrum analyzer limit the quality of the measurement. However, the signal source is often the limiting factor, with harmonic distortion performance on the order of 30 to 50 dB below the fundamental. Figure 1a shows a typical harmonic distortion measurement. The harmonic distortion of a signal is often specified by stating the amplitude of the largest harmonic in dB relative to the fundamental.

Use a low pass filter to improve the source's effective harmonic distortion, as shown in Figure 1b. Choose the cutoff frequency of the low pass filter such that the fundamental frequency is passed largely intact, while the harmonics are attenuated significantly. You can verify the performance of the source/filter combination directly with the spectrum analyzer. If the loss through the filter at the fundamental frequency is significant, the loss should be accounted for when setting the source output level. Use the spectrum analyzer to check the fundamental level at the output of the filter, or for better level accuracy see Hint 2.

Note: You can calculate the percent distortion for a particular harmonic, m th harmonic as,

$$\%d_m = 100 \times 10^{\left(\frac{\Delta dB}{20}\right)}$$

Or you can calculate total harmonic distortion: calculate the distortion for each harmonic as above and find the root sum of the squares,

$$\%THD = \sqrt{\sum(\%d_m)^2}$$

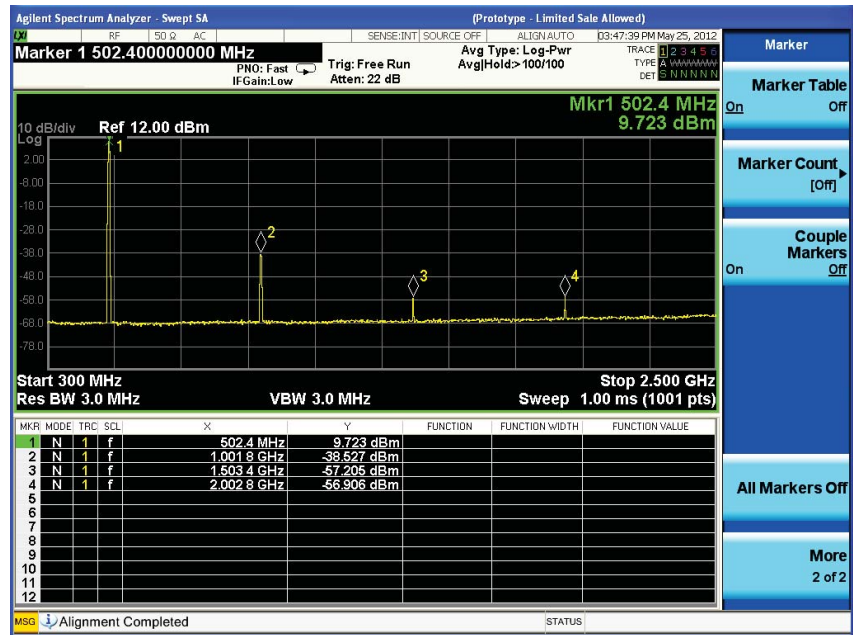

Figure 1a. Harmonic distortion measurement using a signal analyzer.

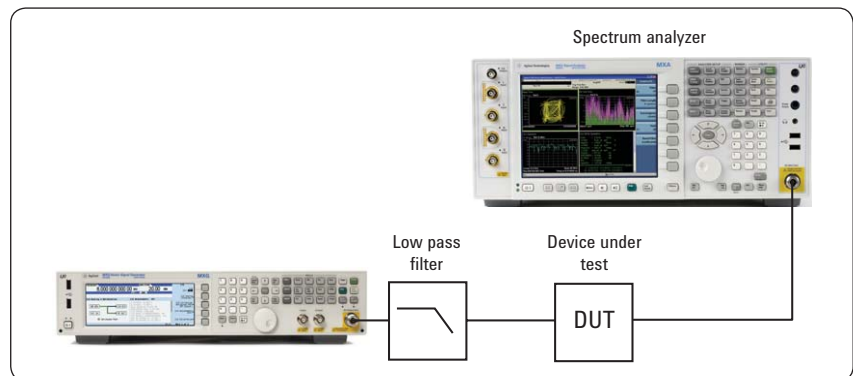

Figure 1b. The harmonic distortion of a signal source improved by installing a low pass filter at the source's output.

HINT 2.

Increase power level accuracy

In your test setup, you are likely to use passive devices such as cables, filters or switches between your source and the DUT. The accuracy of the signal level at the DUT is effected by the use of these components. In some applications, for example receiver sensitivity measurements, the accuracy of the input signal level is critical. To have the desired power applied to the DUT, perform the following test prior to making your measurements. The setup consists of your signal generator, power meter with a power sensor and the cables or switches that are necessary in the measurement as shown in Figure 2.

Calibrate the power meter to the power sensor for an accurate power measurement. It is assumed that you are familiar with the calibration and zeroing of the power meter in use.

Note: the accuracy of the power meter measurement depends on the calibration factors of the sensor; be sure to enter the calibration factors into the power meter prior to calibration.

You can perform the power level calibration with either a USB power sensor or an external power meter. USB sensors are generally the easiest to use, since the signal generators that support them can automatically download the calibration factors for that specific sensor into the signal generator memory. Some signal generators also support external power meters via a remote interface such as LAN or GPIB to automatically download the calibration factors.

Once you have completed the calibration of your power meter, set the power meter's measuring frequency to the signal frequency. Connect the

sensor in place of your DUT as indicated in Figure 2 and measure the power level. If there is a difference between the power meter's reading and the indicated level on the source, use your source's amplitude offset feature to make the necessary adjustments. Match the displayed power level of your source to the power meter's reading. Once you adjust the amplitude at a particular frequency, then the source will automatically display the correct value for different amplitudes at that same frequency. Note that many signal generators perform this correction automatically, applying the power sensor calibration factors to provide corrected output at each frequency. Since the accuracy of the power meter is very high (uncertainty in the tenths of a dB range), you can have confidence that the power level is accurate.

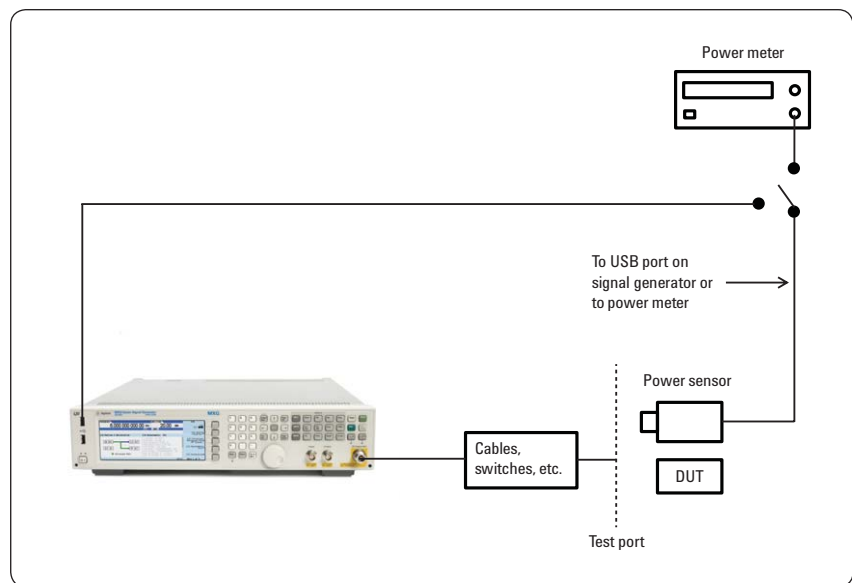

Figure 2. Setup for improving level accuracy of the signal.

HINT 3.

Improve frequency accuracy

For certain measurements, the absolute frequency of the stimulus signal is most important, but other measurements require accurate relative frequency spacing between multiple signals. For instance, to create multi-tone inputs with known frequencies, a classic technique is to combine the outputs of several analog signal generators together. The frequency accuracy of each source relies on its internal frequency standard. It is very possible for these standards to be slightly off in frequency, thereby causing relative frequency errors in the measurement.

For example, assume you are trying to set a 1 kHz separation between two signals centered at 200 MHz, and your sources have $\pm 1 \times 10^{-6}$ /year aging rate. Your sources frequency error in this case is $200 \text{ MHz} \times 1 \times 10^{-6} = \pm 200 \text{ Hz}$. The separation could be anywhere from 600 Hz to 1400 Hz, (see Figure 3). To increase the

accuracy, connect the time bases of the two sources together. Take the reference signal output of one source, usually located on the back panel of the box, and connect it to the reference signal input of the other source. Now the uncertainty of the separation is $1 \text{ kHz} \times 10^{-6}$ or 0.001 Hz.

With a vector signal generator, it is possible to create multi-tone signals with a single signal generator. Since the tones are all generated with a common baseband clock frequency, the relative tone spacing will be extremely accurate.

When the absolute frequency of the signal is important, increase the frequency accuracy of your source by finding the most accurate external-frequency reference available. Choose the instrument in your setup with the most accurate time base and connect all the other equipment to this reference.

Some instrument manufacturers offer high-stability ovenized reference oscillators as an option. These frequency and time standards are extremely accurate, but can be expensive.

You can always improve frequency accuracy by using a house standard (a high-accuracy frequency reference distributed throughout your facility). Connect your signal generators and all your other equipment to this reference. A distribution amplifier may be needed to maintain proper levels and impedance matching.

It should be noted that when using an external frequency reference, the phase noise of that reference may degrade the signal generator's phase noise. Therefore, the phase noise performance of an external reference source should always be taken into consideration before use.

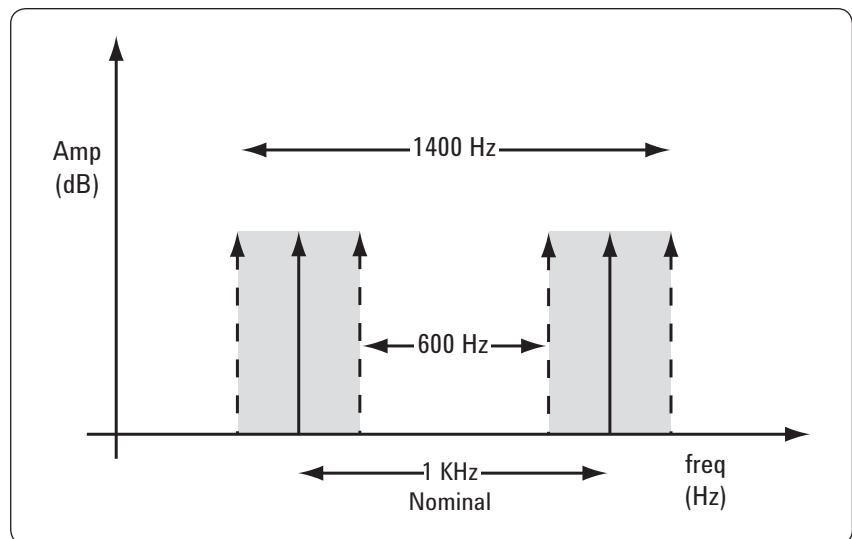

Figure 3. Shaded area illustrates the relative frequency error range of the example.

HINT 4. Improve source match

Source match is important because many test devices present bad matches. Mismatch between the source and the load impedance changes the effective signal input level to the device under test. Complicating the picture, the test device is seldom connected directly to the source. There are cables and often other components, such as adapters and filters between the source and the load. If you are using adapters to accommodate the connector type of the test device, filters to eliminate source harmonics, and so forth,

be aware that these components degrade the source match as seen by the test device. This mismatch may be reduced in several ways. The simplest way is to insert a fixed attenuator with good match at the input of the test device. This improves the effective source match by twice the value of the attenuator in dB.

When a load is not well matched, there is a reflection from the load, which travels back toward the source. Instead of being completely absorbed at the source, some of it is re-

reflected back toward the load. This re-reflected wave adds constructively or destructively at the load, depending on the phase of the signal. From a measurement point of view, concentrate on the maximum and minimum power transfer, which represents the maximum and minimum error that can be incurred due to impedance matching problems.

The following example, in Figure 4, will help illustrate the difference inserting the attenuator will make in the measurement.

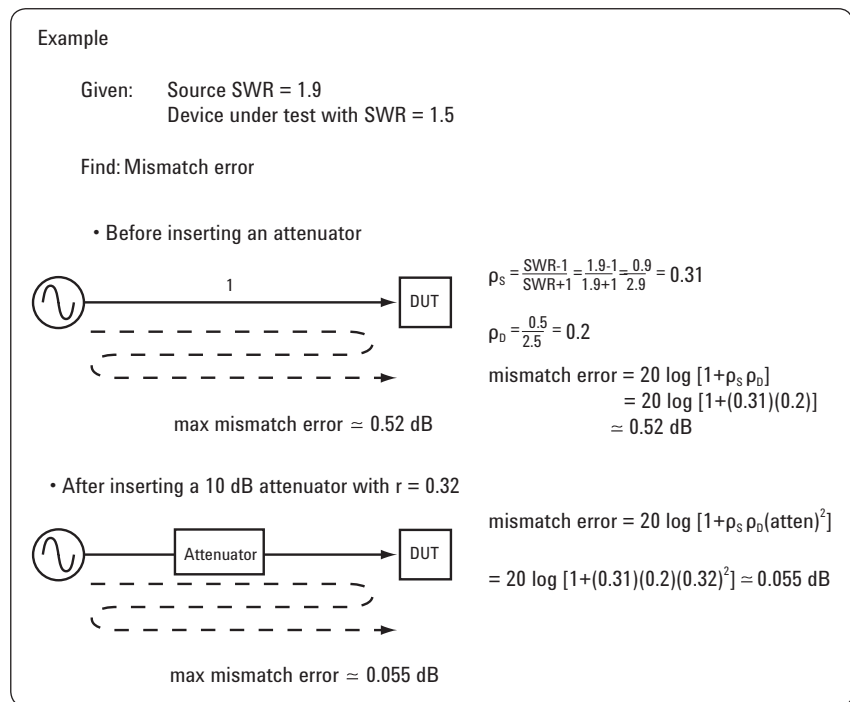

Figure 4. Source match impacts measurement uncertainty.

HINT 5. Making high quality TOI measurements

When combining two sources to make a third-order-intercept (TOI) measurement, it is important that your sources are terminated properly and well isolated from each other. If they are not isolated, the sources can intermodulate with one another, producing intermodulation products at the input of the device under test (Figure 5a). This condition can mask the device's true intermodulation performance.

Each source wants to see a good 50-ohm termination. When using resistive combiners, be sure to use the three-resistor, and not the two-resistor type. See Figure 5b. Two-resistor combiners/splitters are used for leveling applications where one side of the splitter connects to a power meter for accurate level control. For TOI applications, two-resistor combiners don't provide a 50-ohm match on all ports. In addition to providing proper termination at all three ports, three-resistor splitters provide 6 dB of isolation between the two sources.

The best way to combine two sources is to use a directional splitter or directional coupler. They provide good port matches and extra isolation.

You can improve isolation between the sources, regardless of what type of combiner is used, by adding attenuators at the output of each

source (before the signals are combined). Increase the source power to compensate for the extra attenuation. Adding 10 dB attenuators to the output of each source increases the isolation by 20 dB. Another way to increase isolation is to place amplifiers after each source. The reverse isolation of the amplifiers typically provides plenty of isolation between the two sources.

For some sources, turning off the output automatic-level-control (ALC) will decrease intermodulation products. This prevents conflict in power-level control between the two sources. This is less of a problem for wide frequency offsets (100 kHz and higher, typically) since most ALC bandwidths are fairly low when AM is turned off.

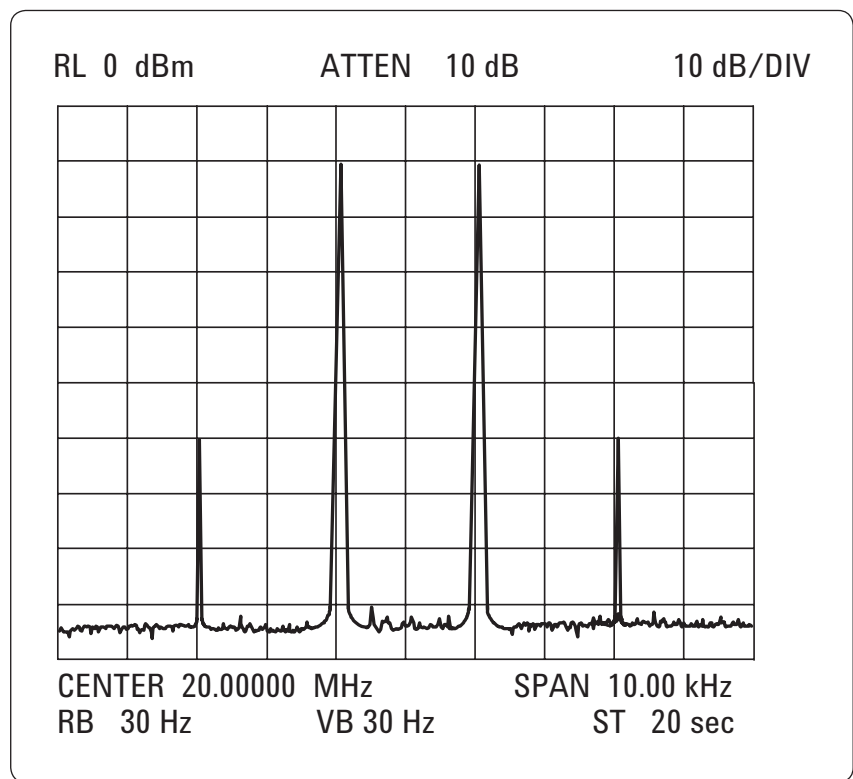

Figure 5a. Example of intermodulation products caused by two sources intermodulating with each other.

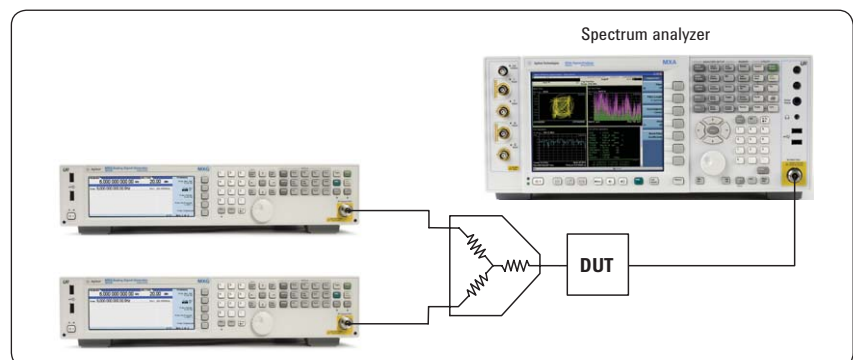

Figure 5b. Three-resistor combiner used to isolate the outputs of the sources.

With a vector signal generator, you can create multiple tones in a single signal generator, as long as the total frequency spacing between the tones is within the baseband generator bandwidth. This eliminates the need for externally combining signals, resulting in a simpler test setup. The dynamic range is limited by the number of effective bits of vertical resolution in the baseband generator. A vector signal generator will also typically exhibit a small carrier feedthrough, as shown in the center of Figure 5c. Using software predistortion techniques, the intermodulation products can be further reduced, as shown in Figure 5d.

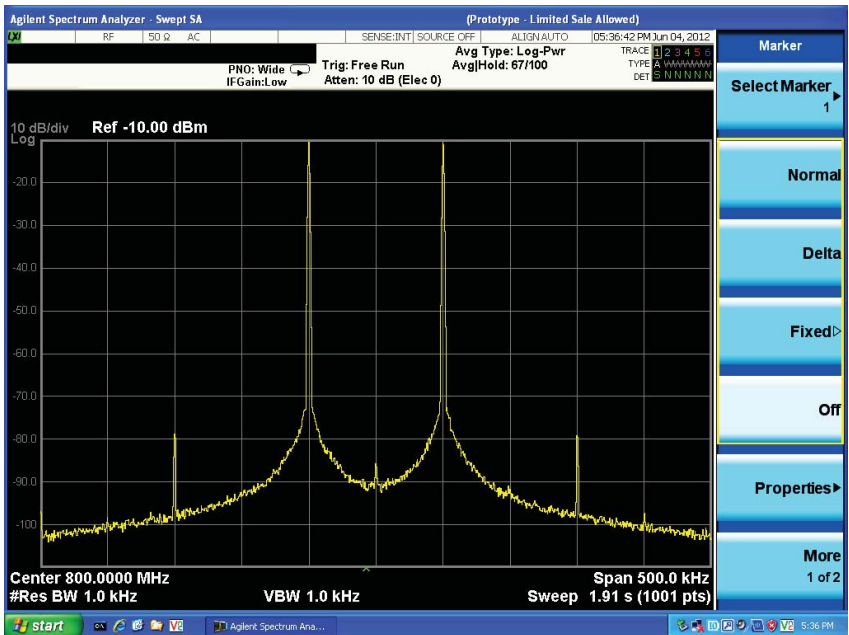

Figure 5c. Two tone signal created on a vector signal generator showing nearly 70 dBc from the two tones to the third-order products.

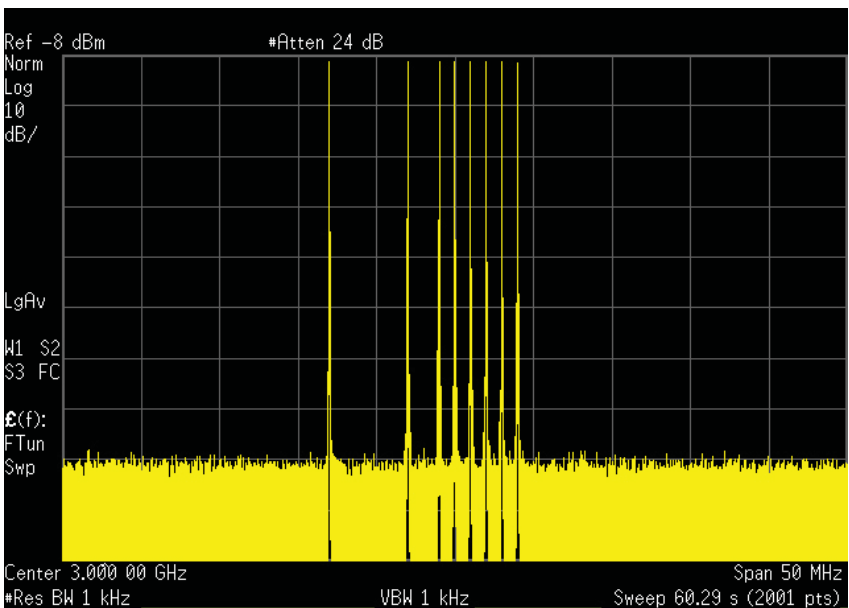

Figure 5d. Unequally spaced tones corrected with predistortion techniques.

HINT 6. Extend the amplitude range

An important specification of any signal generator is the output power range. If you need to go beyond this specified range, use an amplifier to increase or an attenuator to decrease the output power. When you extend the output amplitude range of the source by using one of these devices, there are some important factors to be aware of. The amplifier gain uncertainty affects the output signal level directly. Be aware of the 1 dB compression point of the amplifier. If you need to drive the device too close to this compression point, use a low pass filter at the output to reduce the added harmonic distortion (Figure 6a).

As in the case of the amplifier, there are uncertainties to consider when using an attenuator, such as attenuator flatness and accuracy. For the most accurate measurements, characterize the attenuator using a network analyzer and correct the source power to compensate for any attenuator error.

The techniques discussed in Hint 2, Increase power level accuracy, are also very useful for providing the best possible accuracy when using external amplifiers or attenuators.

Interfering signals are an important source of error especially at very low amplitude levels. These signals are either from external radiation, for example a nearby radio station, or even leakage from the source itself. Leakage from the source affects the level input to the DUT and external noise affects the measurement data. To reduce the inaccuracies, place the DUT in a shielded environment such as a metal box (Figure 6b), or a shielded room. A TEM (transverse electro-magnetic wave) cell may work as well. This will reduce the effect of the external radiation and any signal leakage from your attenuator or source provided they are outside of the cell.

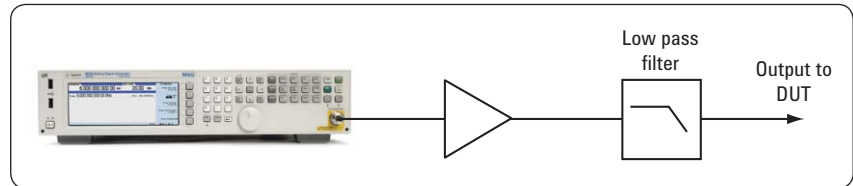

Figure 6a. When increasing amplitude range, use a low pass filter to reduce added harmonic distortion.

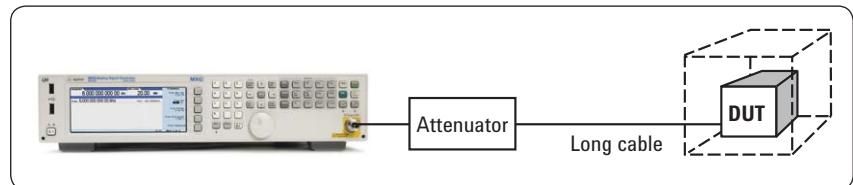

Figure 6b. When decreasing amplitude range, place your DUT in a shielded environment.

HINT 7.

Optimizing for EVM and ACLR for LTE component testing

Unlike previous cellular communication standards such as cdma2000®, W-CDMA, or HSPA, the LTE standard does not define a specific transmission filter. This allows various filter implementations, which may optimize either in-channel performance, resulting in improved EVM, or out-of-band performance, resulting in better ACPR and spectrum mask characteristics. There is a trade-off between these characteristics, so optimizing one of them tends to make the other worse.

For testing components, it is desirable to start with a stimulus signal that has the best possible performance for EVM or ACLR so that any degradation caused by the DUT can be clearly determined. Agilent's Signal Studio software provides different options for filtering to allow users to modify the EVM and ACPR characteristics of the signal. By default, the software turns on an Agilent-defined baseband filter that provides a good

balance between ACPR and EVM performance. To optimize the signal for EVM performance, another type of filtering can be applied by entering a non-zero value for the symbol rolloff length (in units of T_s , where $1T_s = 32.55$ ns). This sets the length of the OFDM windowing that is applied in the time domain to smooth out the discontinuities between OFDM symbols. Increasing the value of this parameter can improve the EVM performance, but it may degrade the ACPR performance.

The examples shown in Figures 7a, 7b and 7c show the result when using different types of filtering. All use a 5 MHz E-TM 1.1 signal that fully allocates all available RBs to the PDSCH using QPSK modulation. Figure 7a shows the results using the default baseband filter. The composite EVM is about 0.53%, while the ACPR is -73.2 dB. Figure 7b shows the results with the baseband filter turned off

and the symbol rolloff length set to 20 T_s . This combination gives the best EVM, but the spectral regrowth in the adjacent channel is quite high. The EVM is about 0.37% while the ACPR is -43.1 dB.

Both types of filtering can be combined to give better EVM performance while maintaining good ACLR. Figure 7c shows the results with the baseband filter turned on and the symbol rolloff length set to 20 T_s . The EVM is 0.46% while the ACPR is -73.1 dB. The measurements in Figure 7c demonstrate the excellent ACLR performance of Agilent's MXG signal generators. Depending on the signal parameters, the MXG typically has 3 to 5 dB better ACLR performance than other signal generators with similar EVM performance, providing additional margin for testing high-performance devices.

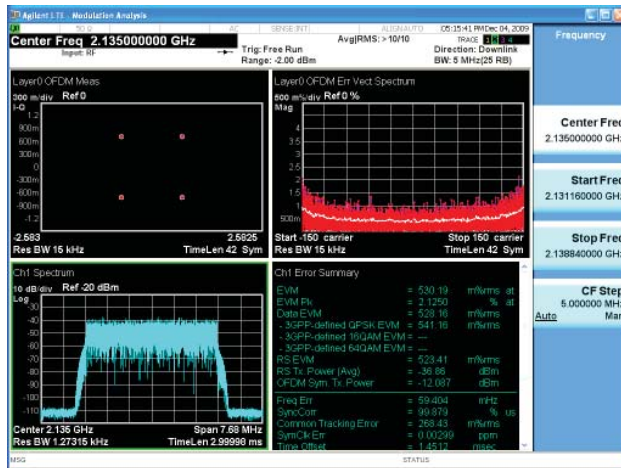
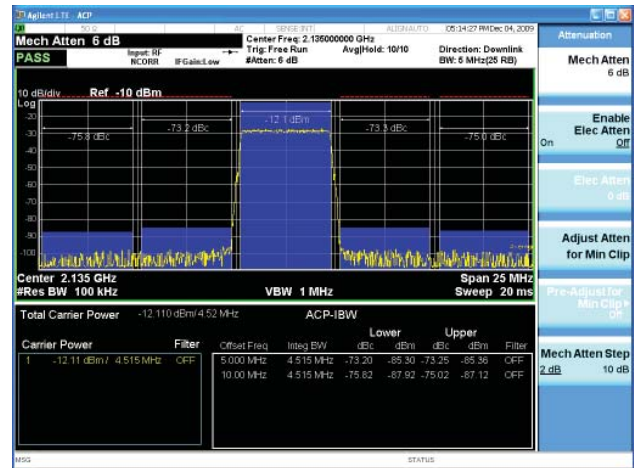

Figure 7a. 5 MHz E-TM 1.1 signal with default baseband filter (best ACLR).



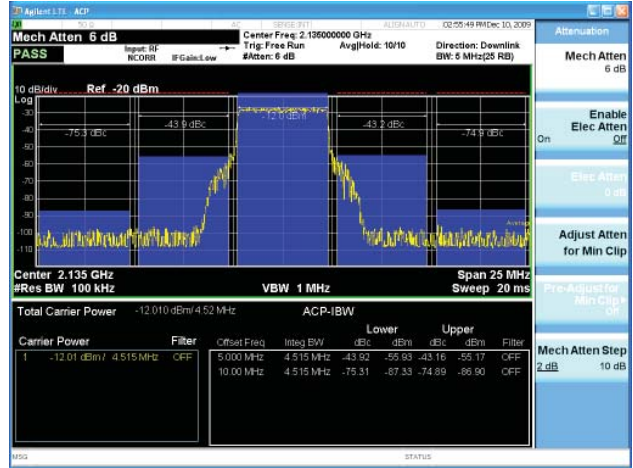
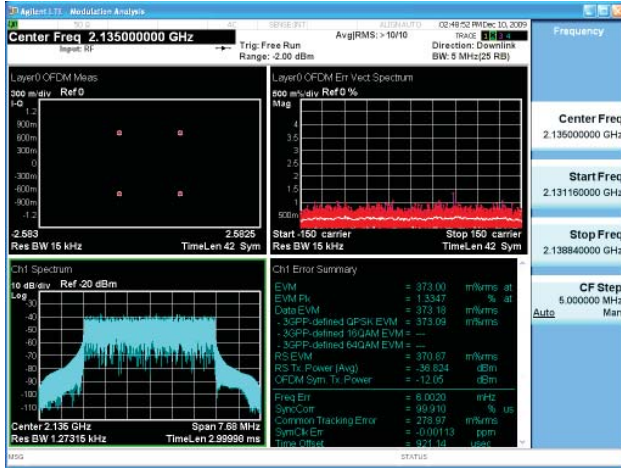

Figure 7b. 5 MHz E-TM 1.1 signal without baseband filter and symbol rolloff length = 20 Ts (best EVM).

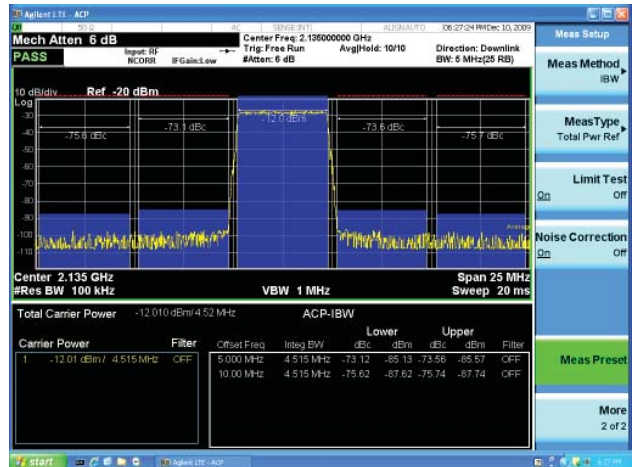
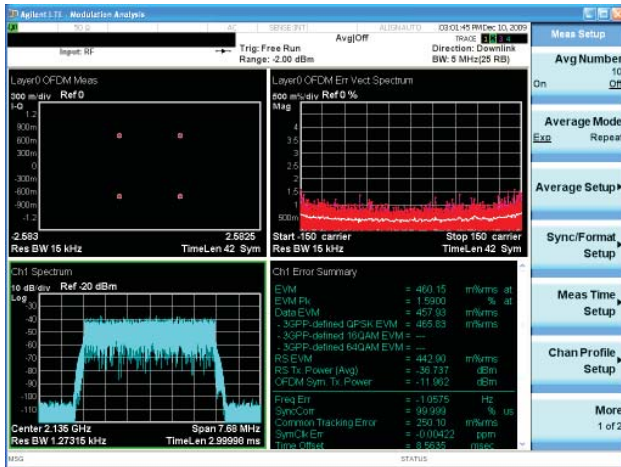

Figure 7c. 5 MHz E-TM 1.1 signal with baseband filter and symbol rolloff length = 20 Ts.

HINT 8.

Select the optimum phase noise profile

Random noise within the source will cause the power to be spread over a small range of frequencies. This spread is referred to as phase noise and is often mathematically modeled as random phase modulation. The units of phase noise are dBc/Hz, or how far down in dB relative to the carrier normalized to a 1 Hz bandwidth. Phase noise is specified at a frequency offset from the source's output. For example, the phase noise of a source may be specified as -131 dBc/Hz at a 20 kHz offset from a signal frequency at 3 GHz.

Some signal generators have a choice of two phase noise modes as shown in Figure 8a. You can tailor performance to either in-channel or out-of-channel measurements. If the phase-lock loop bandwidth of the synthesizer internal to your signal generator is widened, this will yield the minimum phase noise at lower offsets (such as < 150 kHz) for in-channel measurements, but at the expense of increased phase noise at higher offsets. Conversely, if a narrow phase lock loop bandwidth is used, optimum phase noise will be achieved at higher offsets (such as > 150 kHz) for out-of-channel measurements. Now the trade-off is increased phase noise at lower offsets.

Another capability found on several signal generator models is a mode to optimize the signal-to-noise performance. This mode adjusts the ALC level for a given attenuator setting to minimize the broadband noise, as shown in Figure 8b. This mode is recommended for testing broadband receivers and other devices that are sensitive to overall noise power. Phase noise is generally displayed on a log-log axis. This enables both the close-in phase noise (offsets < 1 kHz) and the far-out phase noise (offsets > 1 MHz) to be easily examined on one plot.

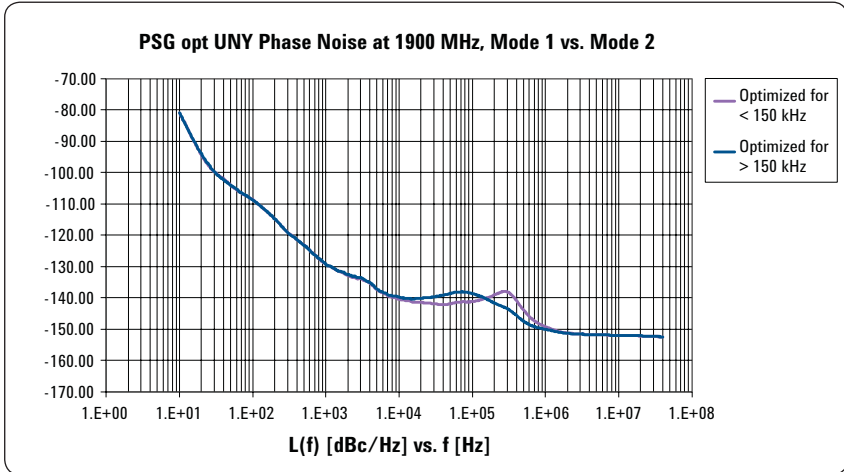

Figure 8a. Adjust the phase lock loop bandwidth to optimize the phase noise.

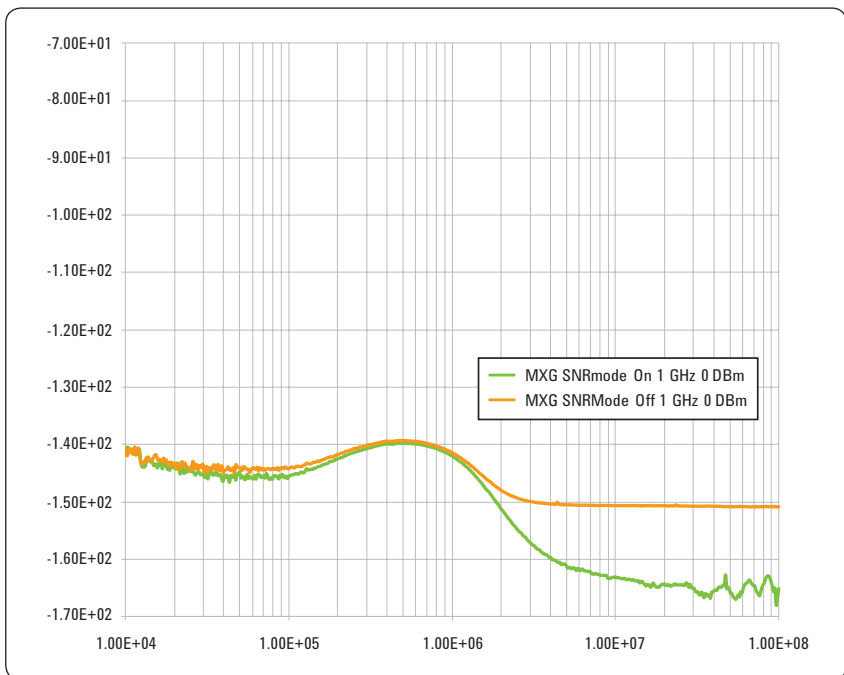

Figure 8b. Optimize the signal-to-noise ratio to reduce broadband noise.

Agilent X-Series Signal Generators

N5171B/N5181B EXG/MXG

X-Series analog signal generators

Frequency coverage:

9 kHz to 1/3/6 GHz

Output power range:

+24 to -127 dBm

Electronic attenuator

Level accuracy:

± 0.6 dB to 6 GHz

Frequency switching speed:

SCPI mode ≤ 950 μs

List/step sweep mode ≤ 800 μs

Amplitude switching speed:

SCPI mode ≤ 650 μs

List/step sweep mode ≤ 300 μs

Phase Noise:

-146 dBc/Hz typical at 20 kHz offset,

1 GHz carrier

Connectivity:

1000BaseT LAN, GPIB, USB 2.0

Expandable capabilities:

Optional built-in function generator

Optional AM/FM/ΦM/pulse modulation

N5172B/N5182B EXG/MXG

X-Series vector signal generators

Frequency range:

9 kHz to 3/6 GHz

External RF bandwidth:

200 MHz

Internal baseband generator capability:

Up to 100 Msymbols/s, 160 MHz RF bandwidth

Baseband memory:

32 to 1024 Msa

Baseband sample rate:

Up to 200 Msa/s (16-bit, 800 MHz

DACs 4X oversampling)

Signal storage memory:

30 GByte

Formats and features:

Custom modulation: PSK, QAM, FSK,

MSK, ASK, and custom I/Q

Real-time applications:

LTE/LTE-Advanced FDD, LTE/LTE-

Advanced TDD, W-CDMA/HSPA+,

GSM/EDGE/Evo, cdma2000/1xEV-DO,

Global Navigation Satellite Systems

(GNSS), Digital Video, Broadcast Radio



Web

www.agilent.com/find/X-Series_SG
www.agilent.com/find/MXG
www.agilent.com/find/EXG

Literature

X-Series Signal Generator Selection Guide,
Literature number 5990-9956EN

X-Series Signal Generator Brochure,
Literature number 5990-9957EN

MXG Data Sheet,
Literature number 5991-0038EN

MXG Configuration Guide,
Literature number 5990-9959EN



Agilent Email Updates

www.agilent.com/find/emailupdates
Get the latest information on the products and applications you select.



www.lxistandard.org

LAN eXtensions for Instruments puts the power of Ethernet and the Web inside your test systems. Agilent is a founding member of the LXI consortium.

Agilent Channel Partners

www.agilent.com/find/channelpartners

Get the best of both worlds: Agilent's measurement expertise and product breadth, combined with channel partner convenience.

cdma2000® is a registered certification mark of the Telecommunications Industry Association. Used under license.



Agilent Advantage Services is committed to your success throughout your equipment's lifetime. To keep you competitive, we continually invest in tools and processes that speed up calibration and repair and reduce your cost of ownership. You can also use Infoline Web Services to manage equipment and services more effectively. By sharing our measurement and service expertise, we help you create the products that change our world.

www.agilent.com/find/advantageservices



www.agilent.com/quality

www.agilent.com
www.agilent.com/find/X-Series_SG

For more information on Agilent Technologies' products, applications or services, please contact your local Agilent office. The complete list is available at:

www.agilent.com/find/contactus

Americas

Canada	(877) 894 4414
Brazil	(11) 4197 3600
Mexico	01800 5064 800
United States	(800) 829 4444

Asia Pacific

Australia	1 800 629 485
China	800 810 0189
Hong Kong	800 938 693
India	1 800 112 929
Japan	0120 (421) 345
Korea	080 769 0800
Malaysia	1 800 888 848
Singapore	1 800 375 8100
Taiwan	0800 047 866
Other AP Countries	(65) 375 8100

Europe & Middle East

Belgium	32 (0) 2 404 93 40
Denmark	45 45 80 12 15
Finland	358 (0) 10 855 2100
France	0825 010 700*
	*0.125 €/minute
Germany	49 (0) 7031 464 6333
Ireland	1890 924 204
Israel	972-3-9288-504/544
Italy	39 02 92 60 8484
Netherlands	31 (0) 20 547 2111
Spain	34 (91) 631 3300
Sweden	0200-88 22 55
United Kingdom	44 (0) 118 927 6201

For other unlisted countries:

www.agilent.com/find/contactus

Revised: January 6, 2012

Product specifications and descriptions in this document subject to change without notice.

© Agilent Technologies, Inc. 2012
Published in USA, June 27, 2012
5988-5677EN



Agilent Technologies