



German WW2 Radar

land-based, naval and airborne systems

Adam Farson
VA7OJ



Radars manufacturers



- **GEMA (Ges. für Elektroakustische u. Mechanische Apparate)**
 - ◆ Berlin-Köpenick; RFT after WW2, part of DeTeWe after 1989
 - ◆ Freya land-based and Seetakt naval shipboard search radars
 - ◆ Jagdschloss long-range land-based PPI radar for urban defence
- **Lorenz AG**
 - ◆ Stuttgart; now Alcatel-SEL
 - ◆ Lichtenstein airborne-intercept (AI) radar
- **Telefunken**
 - ◆ Ulm; later AEG-Telefunken, until 1985 bankruptcy
 - ◆ Würzburg, Würzburg-Riese (Giant) gun-laying & range/height radars
 - ◆ Berlin & Bremen airborne microwave PPI radars, modelled on British H2S
- **Siemens & Halske AG**
 - ◆ Berlin; later Siemens AG, Munich, Berlin & Erlangen

Radars technology



— • — • — — • — — • • • — • — — • • • — • • • • — • — • • • — •

■ Decimetric radars (125 – 600 MHz)

- ◆ Transmitters: Push-pull power oscillators with glass triodes e.g. TS6, LS180, RD12Tf
- ◆ Receivers: superhet with thermionic-diode mixer, triode LO, conventional IF strip & detector with common pentodes e.g. RV12P2000
 - ▶ Mixer noise figure: 16 dB typ. (1N21C silicon diode: 6 dB typ.)
- ◆ Pulse modulators: Spark gap or inert-gas thyratron
- ◆ Displays & indicators: Multiple CRT's for azimuth, range, height indication. Single CRT with rotary deflection yoke for PPI (plan-position indicator).

■ Microwave radars (3.3 GHz)

- ◆ Transmitter: Cavity magnetron LMS 10 (copy of British CV64)
- ◆ Receivers: superhet with solid-state mixer, split-anode magnetron LO

Freya land-based radar (FuMG 39G)



- Early-warning/search radar
- Supplier: GEMA, Berlin
- First 8 units deployed in 1938
- Separate TX, RX & IFF arrays
- Frequency range 120 – 166 MHz
- Range 60 km, later 120 km
- Azimuth accuracy $\pm 1.5^\circ$
- Transmitter output 8 kW
 - ▶ peak pulse
- PRF: 1000 Hz
- TS6 triodes in TX PA
- Full-wave dipole array
- Later version (Freya-AN) used lobe-switching for more accurate targeting

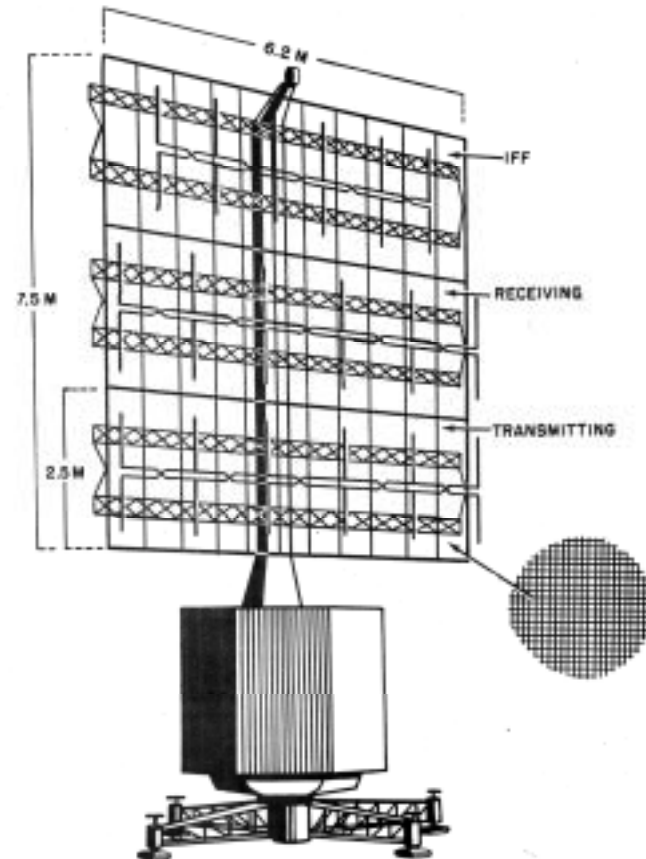

Freya images

Transportable Freya system

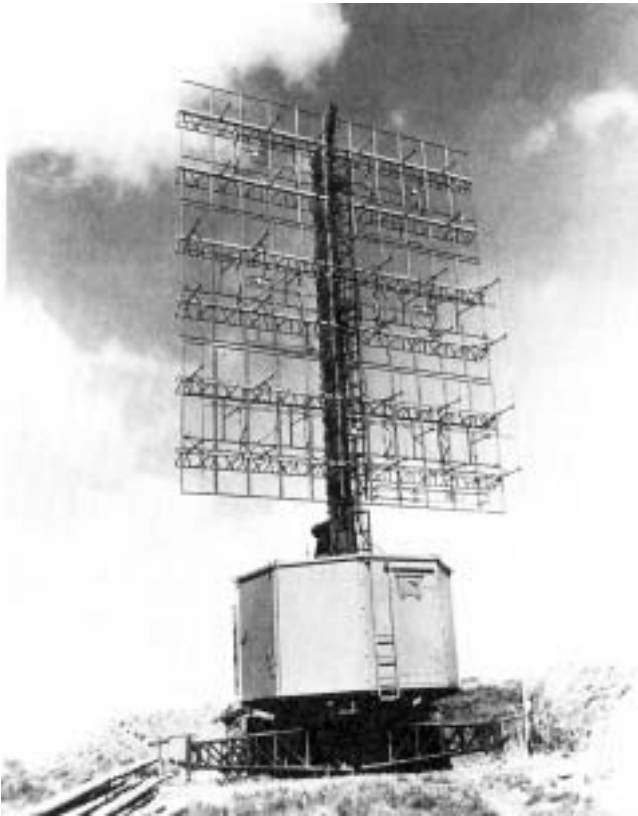

126 MHz Transmitter



Receiver with acorn tubes

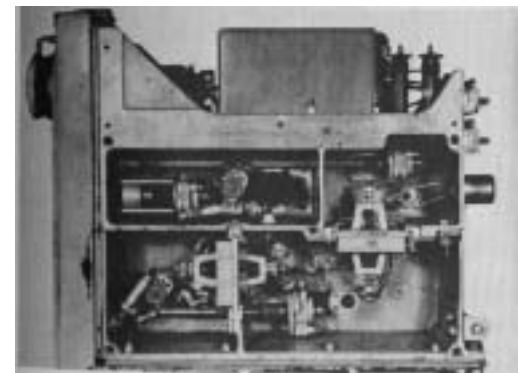

Typical radar equipment bay (Freya-LZ)

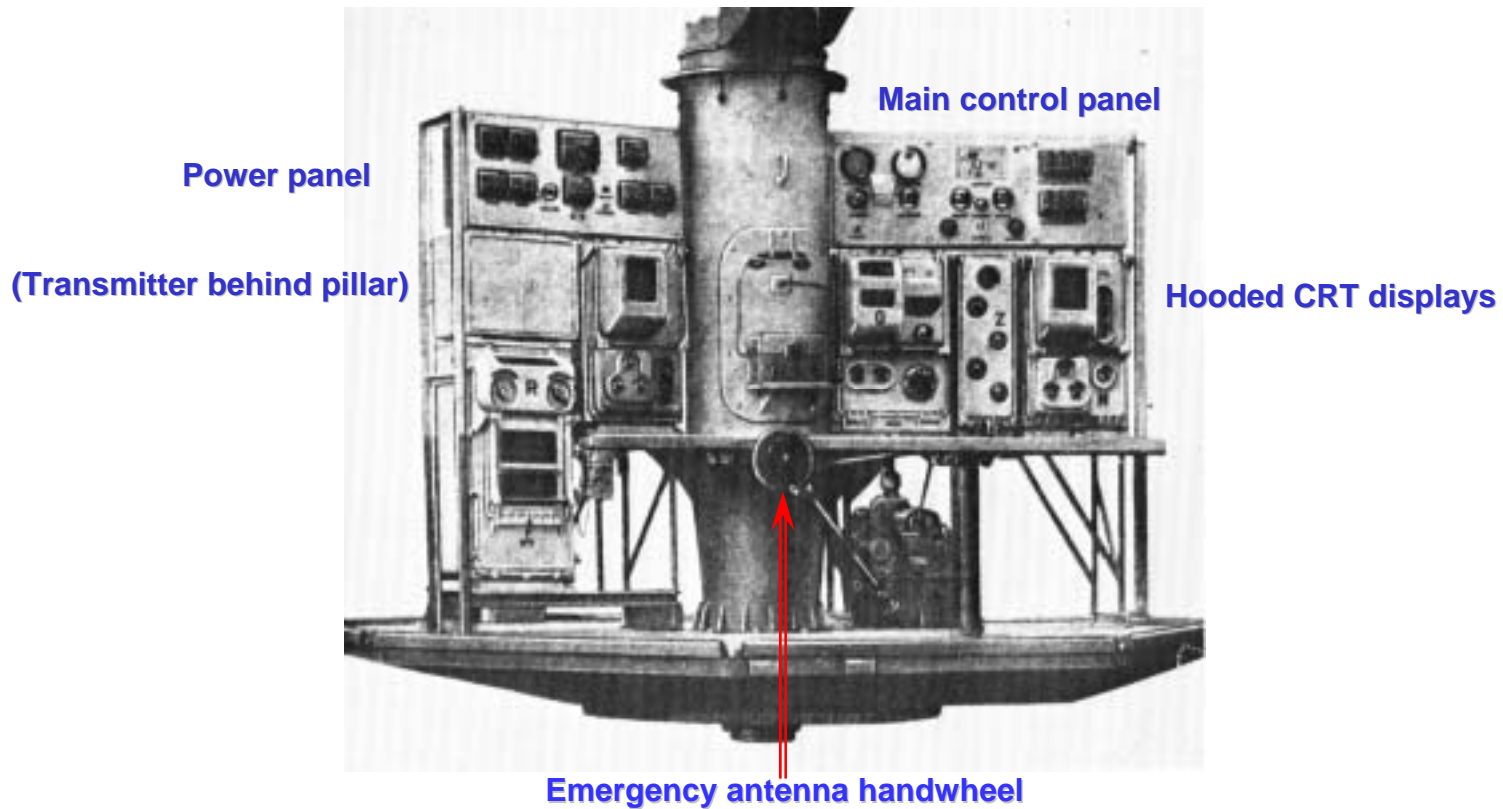

Freya block diagram

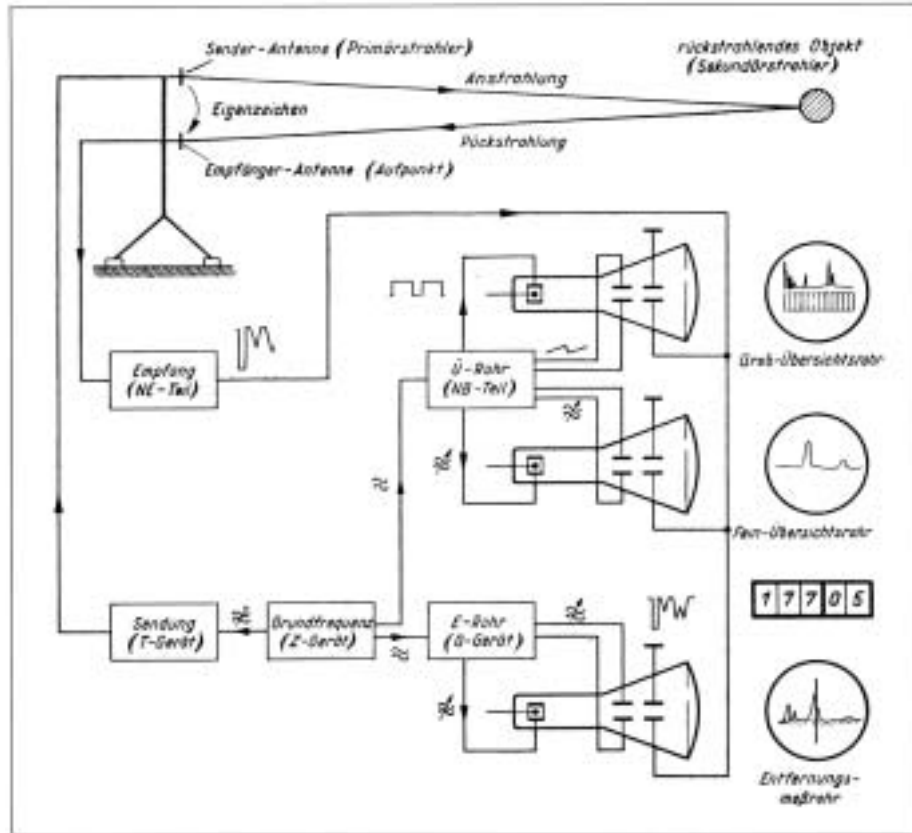

CRT Displays

Coarse search (max. 150 km)

Fine search (any 20 km "slot")

Range (50 km/div. Resolution ± 150 km)

Freya lobe-switching for more precise targeting

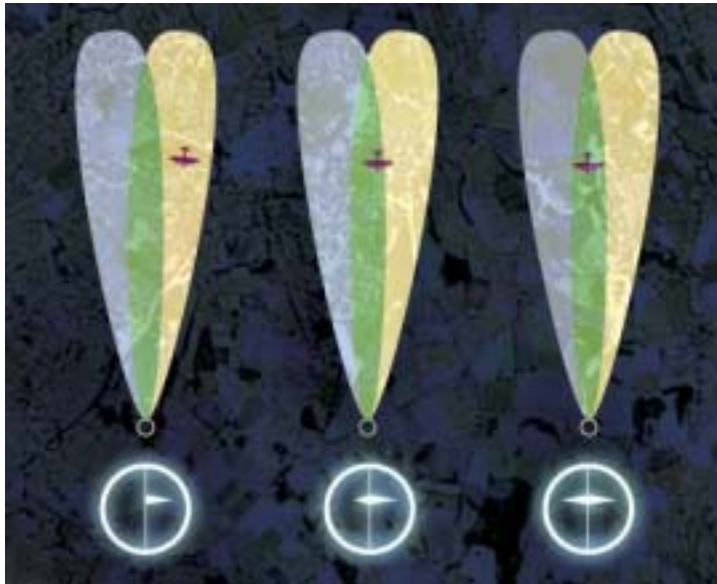

- Left:** Target in right-hand lobe of radar.
- Centre:** As target moves toward beam centre, echoes on left and right of scope become more symmetrical.
- Right:** Target centred in beam, spikes symmetrical.



- Top:** Fighter is behind and to left of bomber.
- Centre:** Crossing left to right.
- Bottom:** Fighter is crossing but approaching firing range.
- Clutter at bottom of scope is permanent ground echo.*

Seetakt naval radar

FuMO 23



- Shipboard search/gun-ranging radar
- Freya variant, developed by GEMA
- Mounted on mast above rangefinder
- First sea trial: 1935
- Separate TX & RX arrays
 - ▶ full-wave dipoles
- Frequency range 250 – 430 MHz
- Range 14 km, later 25 km
- Azimuth accuracy $\pm 30^\circ$
- Transmitter output 1 kW, later 8 kW
 - ▶ peak pulse
- PRF: 1000 Hz
- TS1 triodes in TX PA
 - ▶ later more powerful TS6

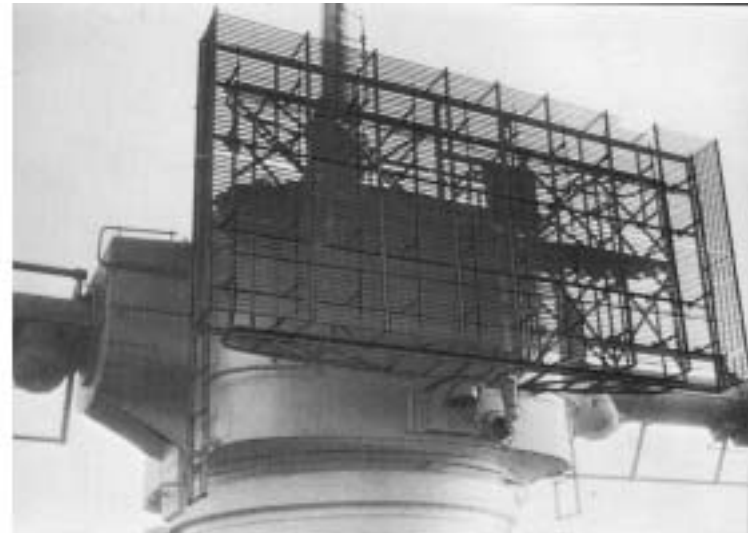

Seetakt antenna aboard Bismarck

Seetakt transmitters



Early 1.5 kW transmitter (2 x TS1)

Later 8 kW transmitter (2 x TS6)



Shock-waves from gunnery destroyed tubes. Ship blinded when spares ran out (examples: Tirpitz, Bismarck).

Würzburg radar systems (FuMG 62)



- Precision gun-laying radar
- Supplier: Telefunken, Ulm
- First demonstrated July 1939
- Frequency range 553 – 566 MHz
- Range 29 km \pm 25m
- Azimuth accuracy \pm 2°
- Elevation accuracy \pm 3°
- Transmitter output 7 - 11 kW
 - ◆ Pulse 2 μ S, PRF 3750 Hz
- LS180 triode in TX PA
- 3m \varnothing paraboloid dish antenna
 - ◆ folded for transport
- D model used nutating “Quirl” dipole feed (25 Hz rotation)
- Networked with Freya for fighter control ([Himmelbett](#))



Würzburg-Riese (giant) radar (FuMG 65)



- Supplier: Telefunken, Ulm
- Introduced: 1941
- Number built: approx. 1500
- Range: up to 70 km
- Dish diameter: 7.5m
- Azimuth: $0-360^\circ \pm 0.2^\circ$
- Elevation: $0-90^\circ \pm 0.1^\circ$
- Precision: $\pm 15\text{m}$
- Excellent gun-laying radar
- Same electronics as Würzburg FuMG 62
- British special forces captured a Würzburg in Bruneval raid (2/1942)



Würzburg-Riese in Douvres (France)

Würzburg front end block diagram

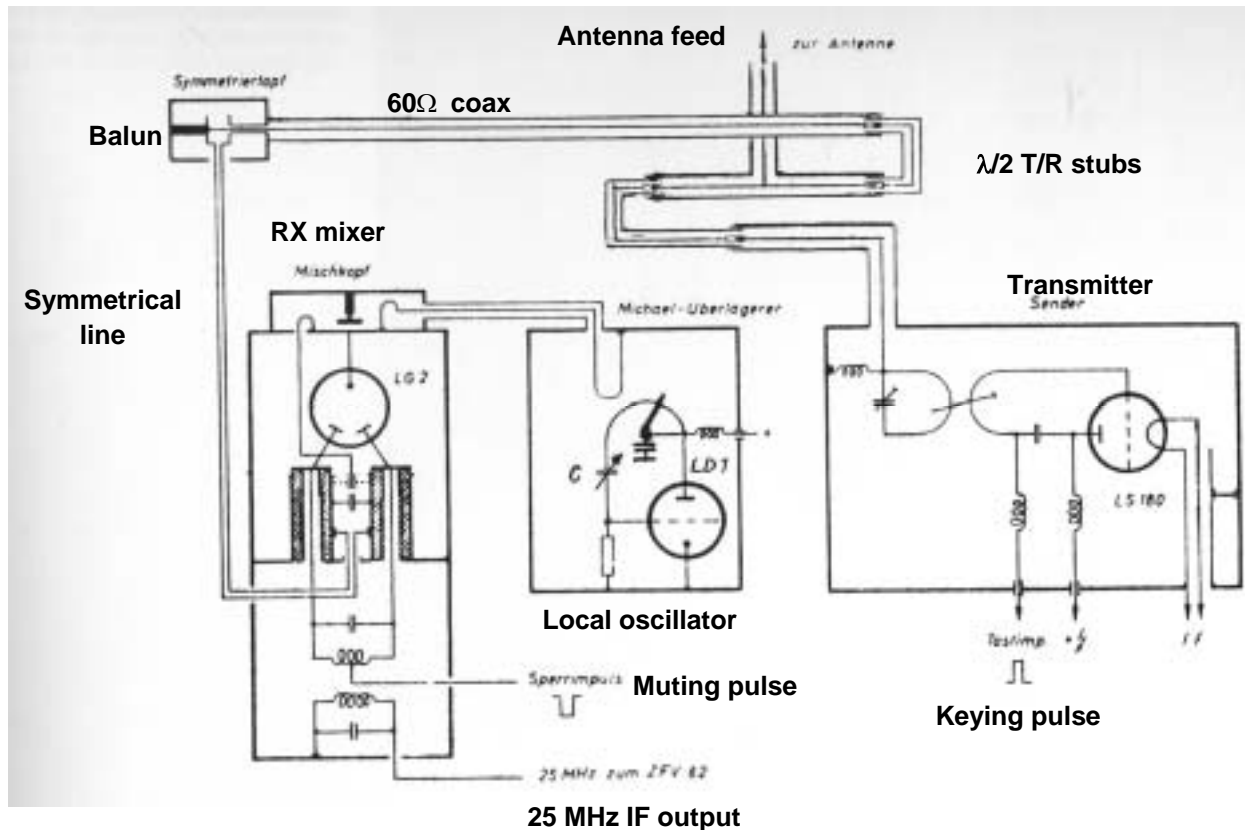

Würzburg front end illustrations

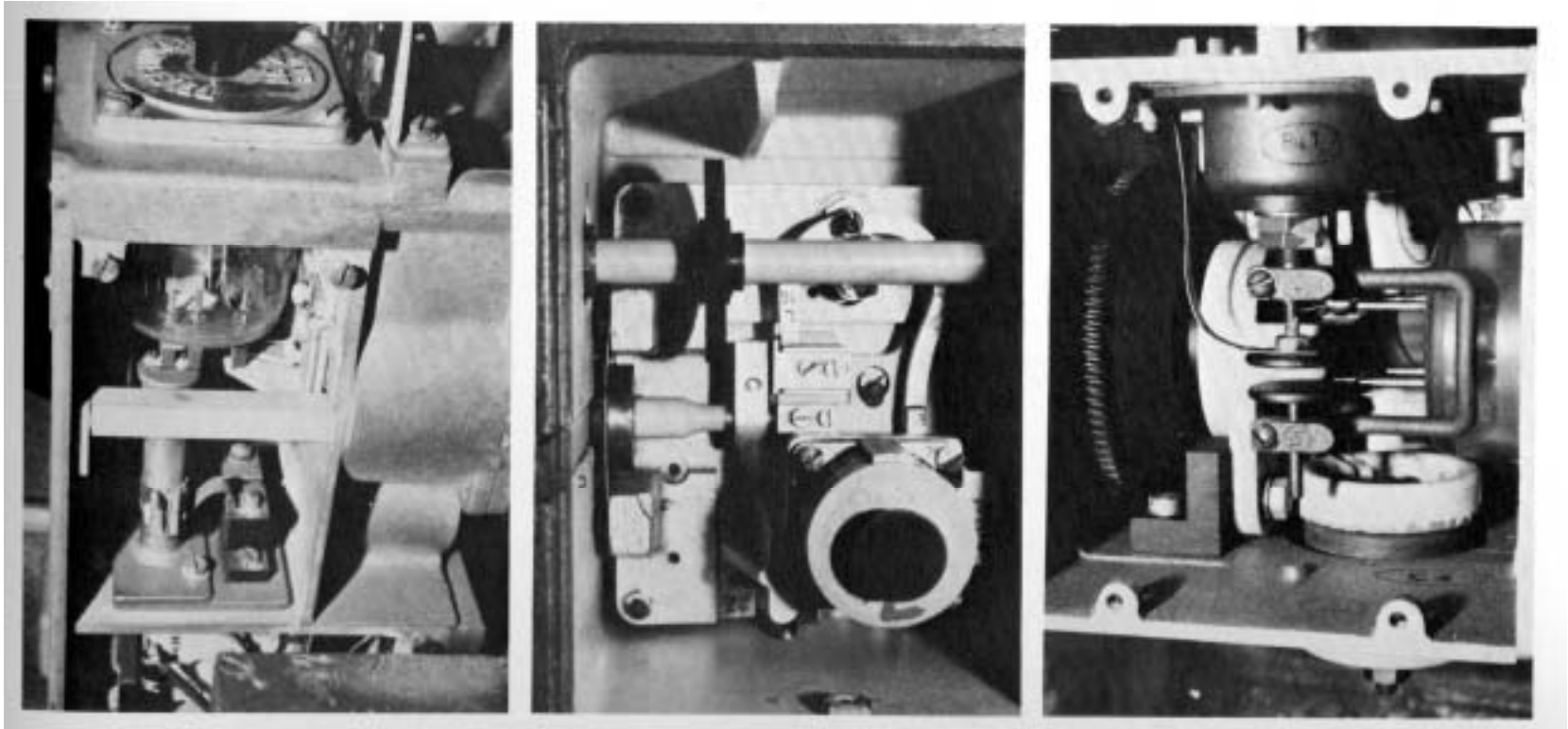

Receiver Mixer

Receiver Local Oscillator Transmitter Output Tank

Würzburg displays

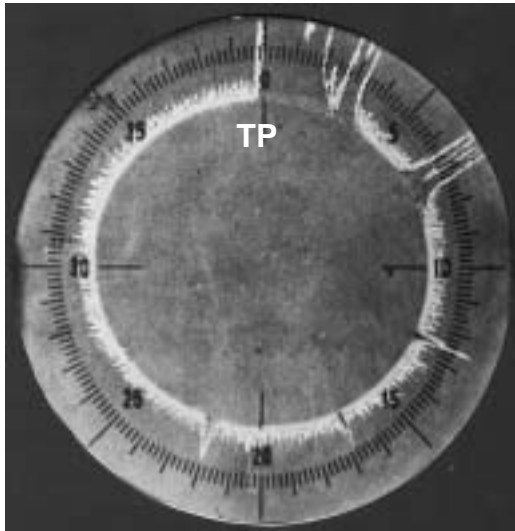

Main range display
TP = transmitter pulse

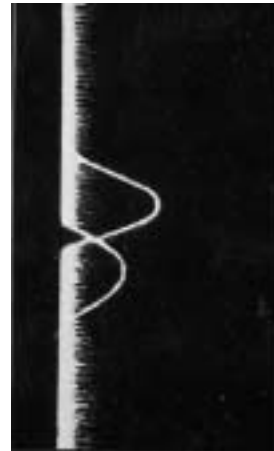

Elevation (EL) display

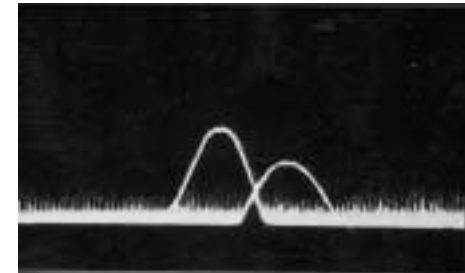

Azimuth (AZ) display

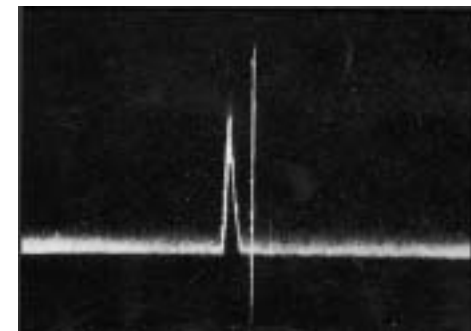

Fine range display

The operator steers the antenna manually in AZ and EL. When the radar beam is centred on the target, the two echoes on the EL and AZ displays are equal in amplitude, and a dark marker appears in the echo pulses on the range displays. Fine range is determined by aligning the cursor with the fine range echo and reading an associated scale.

Typical radar tubes



GEMA TS6 Triode
Freyja/Seetakt PA (x2)



Telefunken LD1 Triode
Würzburg RX Local Osc.



Lorenz RD12Tf Triode
FuG200 TX PA (x2)



Telefunken LG2 Dual Diode
Würzburg RX Mixer (NF 16 dB)



Telefunken LS180 Power Triode: Würzburg TX PA
Peak pulse output 7 – 11 kW



1N416 Si Mixer Diodes: used in US and
British radar receivers (NF 6 – 7 dB)

Radars performance

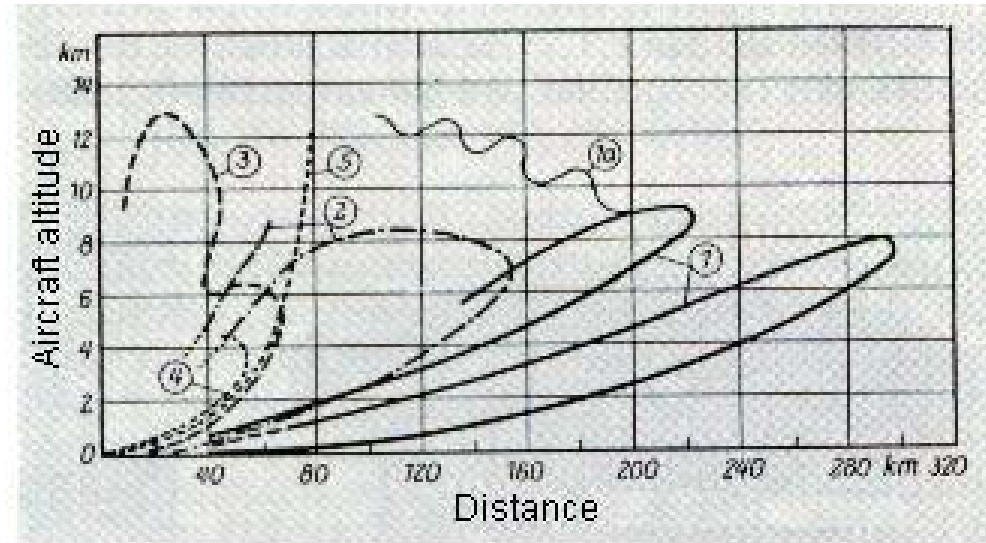

Measured performance of early radar sets, distance and altitude in km.

1. Wassermann FuMG 402 (larger Freya variant) over water.
2. Jagdschloss FuMG 404 over land.
3. Freya FuMG 41 8 kW.
4. Würzburg-Riese.
5. Würzburg-Riese with GEMA retrofit.

Lichtenstein airborne radars

FuG 202 (B/C), 212 (C-1), 220 (SN-2), 228



Messerschmitt Bf 110 G-4 in the RAF museum at Hendon, with second-generation FuG 220 (Lichtenstein SN-2) and nose-mounted antenna array. These large antenna structures had significant drag, and could lop as much as 50 km/h off the top speed of an aircraft.

Lichtenstein specs

Main mission: airborne interception



Model	FuG 202 (B/C)	FuG 212 (C-1)	FuG 220 (SN-2)
Manufacturer	Lorenz AG Stuttgart		
Year deployed	1942	1943	Late 1943
Freq. range	490 MHz	420-480 MHz	72-91 MHz
P _o (peak pulse)	750W	750W (?)	2.5 kW
Max. range	4 - 5 km	6 km	8 km
Min. range	100 - 150m	?	500m
Beam width	±20°	±30°	±45°
Receiver circuit	Super-regen*	Super-regen*	Superhet
Receiver MDS	-79 dBm	-80 dBm	-90 dBm
TX PA stage	2 x RS394	2 X LS30	2 x LD15
Antennas	Arrays of 2-el. Yagis with electronic lobe switching		
<i>* with specially-designed AGC circuit to reduce jamming susceptibility</i>			

FuG 202 simplified block diagram



Antennas: L/U L/D R/U R/D

The Lichtenstein FuG202 radar consists of TX, RX, T/R switching unit, multi-element directional antenna array, motor-driven antenna/display switch and indicator unit.

The antenna switch feeds the antenna sections in varying phase to swing the antenna polar diagram left, right up and down (lobe-switching in AZ and EL).

The indicator has 3 CRT's. one (Range) has a circular time base, and the other two (AZ and EL) have normal straight traces, vertical and horizontal respectively.

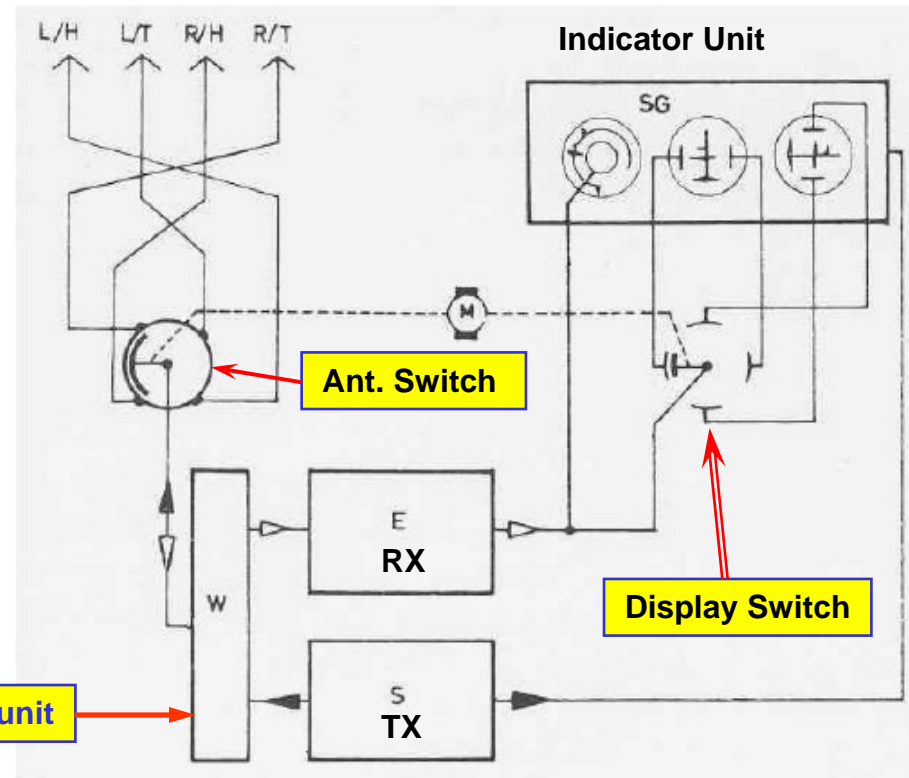

These systems operated on a fixed frequency, which greatly facilitated Allied jamming. The later FuG220 operating below 100 MHz was more immune, but also finally succumbed to Allied ECM.

Lichtenstein display (cockpit indicator unit)

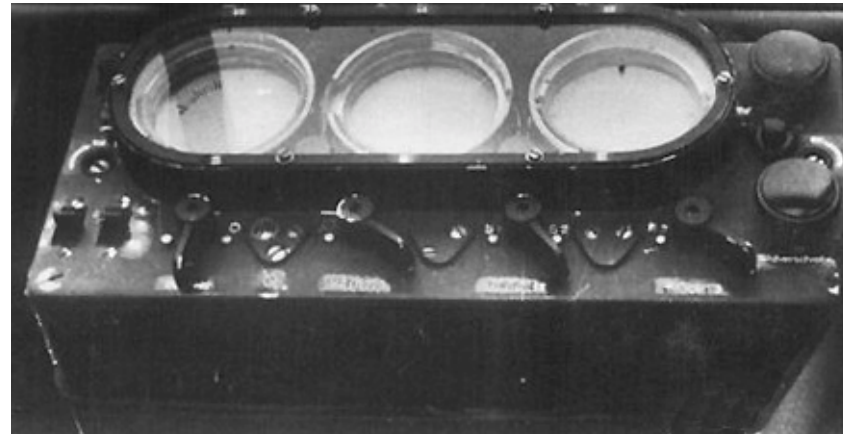
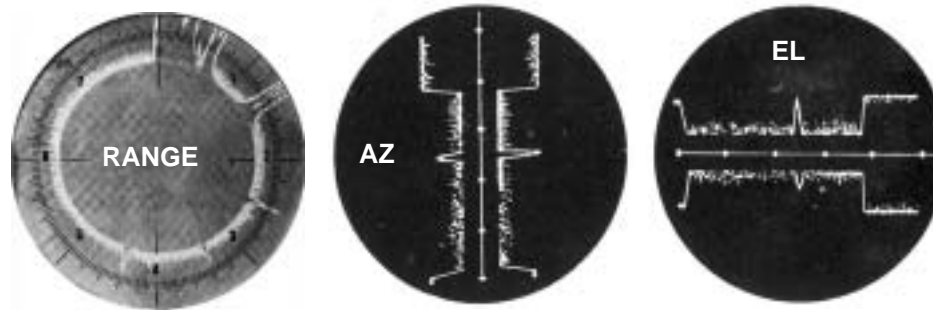

The indicator consists of three adjacent 8 cm Ø scopes: a range scope with circular display reading up to 8 km, and AZ & EL scopes. With 2 km markers as shown here, the target is at 5 km range, to starboard of and above the beam. Ground clutter is at 7.5 km = altitude. The range scope display would show an echo at the 5 km mark.

Notes on microwave radar



- It has been reported * that Hitler personally ordered the cessation of all microwave research in 1941-42. Early in WW2, German scientists tried to get his permission to work on the development of microwave radar. When told this might take several years, Hitler refused. His policy required that scientific research produce usable applications for the military within 6 months' to a year's time.
- Still, German intelligence and scientific personnel were desperate to discover what the Allies were using. They combed downed Allied bombers for radar equipment, hoping to piece together a working radar set, or even a recoverable microwave radar system. Ultimately they succeeded in salvaging enough of an RAF H2S set (including the cavity magnetron) from the wreckage of a Stirling bomber in Rotterdam to build a workable system.
- In late 1943 or early 1944, Hitler was invited to view an operating H2S. The screen display showed a detailed radar street map of Berlin. Rumours say this was the first time Hitler contemplated committing suicide. Attempts to copy the CV64 cavity magnetron initially ran into trouble when *Glashütte Otto Schott GmbH* in Jena failed to duplicate the glass/metal seals.
- The *FuG 224* and *FuG 240 Berlin* 9 cm (3.3 GHz) airborne radars were based on H2S, and used captured examples of the British cavity magnetron. The parabolic dish antenna was installed inside a streamlined nose cover. Between 30 to 50 were issued to service units, mostly on the Ju 88G-6.

* **Source: Fritz Trenkle, "Die deutschen Funkmeßverfahren bis 1945"**

Berlin N1 airborne microwave radar (FuG 240/1)



- Supplier: Telefunken
- Based on RAF H2S captured in February 1943
- Transmitter: LMS 10 cavity magnetron (copy of UK CV64)
- Frequency: 3.3 GHz (9 cm)
- $P_o = 15\text{-}20$ kW peak pulse
- PRF = 1.5 kHz (1 μ S pulse)
- Receiver NF 26 dB
- RX IF bandwidth 5.6 MHz
- Range: 5 km max., 350m min.
- FuG 240/1 shown here had steerable dish and AZ-EL display similar to Lichtenstein
- TX magnetron/pulse modulator, RX mixer/IF preamp mounted in enclosure behind dish
- RX LO in indicator unit; LO signal fed to dish assembly via low-loss coax

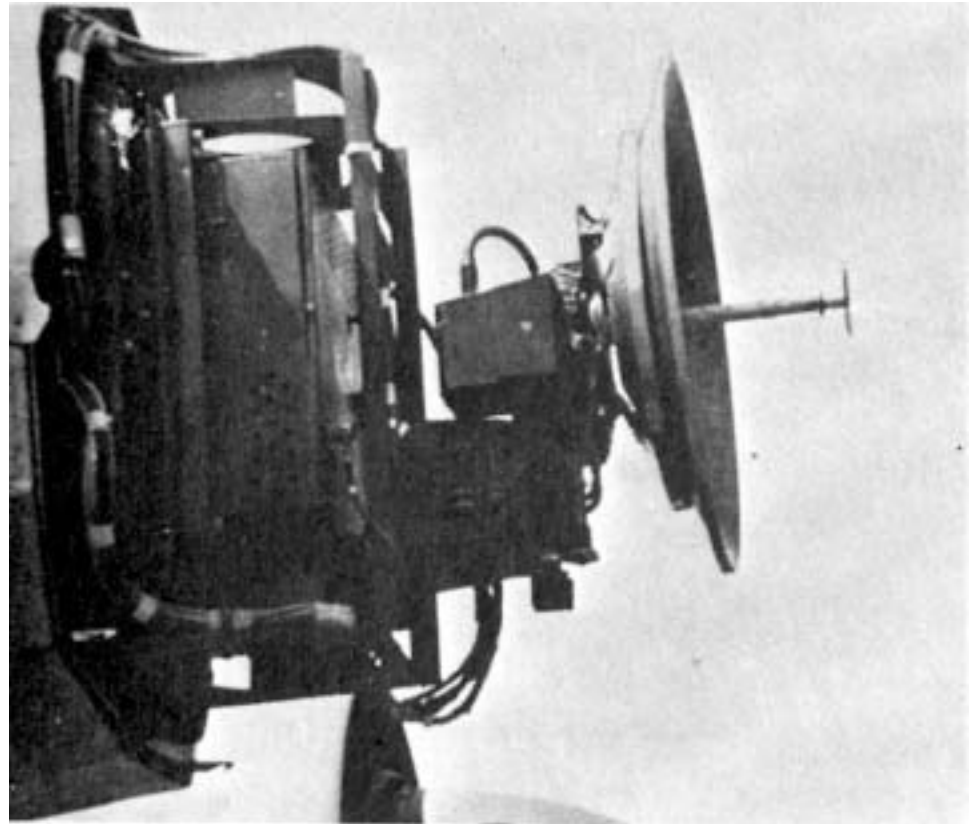

Berlin A PPI radar (FuG 224)



Cockpit indicator unit with PPI (r.)
and EL (l.) scopes



4-element polyrod
antenna, downward-
looking & rotating at
400 rpm.

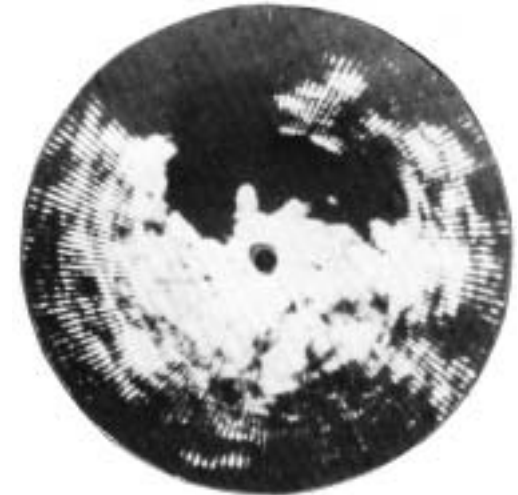

Typical PPI display: outer
range ring 18 or 60 km

Berlin A (FuG 244) was developed by Telefunken, based on captured RAF H2S and US AN/APS-13. First deployed early 1944; only approx. 50 units built. It embodies most of the PPI radar concepts still in use to this day. The polyrod antenna had the same pattern as a dish, but offered much less wind load. It was mounted in a low-loss composite radome on the airframe's underbelly. The high rotation speed eliminated the need for a long-persistence CRT and allowed ambient-light viewing.

Microwave radar tubes

British CV64 vs. German LMS 10



British CV64 cavity magnetron: 40 kW peak pulse at 3.3 GHz



RD 2 Md split-anode magnetron:
(3 GHz, 0.4W CW) used as RX LO
in all Berlin 9 cm radars

German LMS 10
cavity magnetron:
15 kW peak pulse
at 3.3 GHz



Unlike the CV64, which used a permanent magnet, the LMS 10 employed an electro-magnet fed via a current regulator. In the event of magnet failure or overheating, an interlock shut down the HV supply to prevent excessive anode dissipation.

The microwave power race

Germany vs. Britain

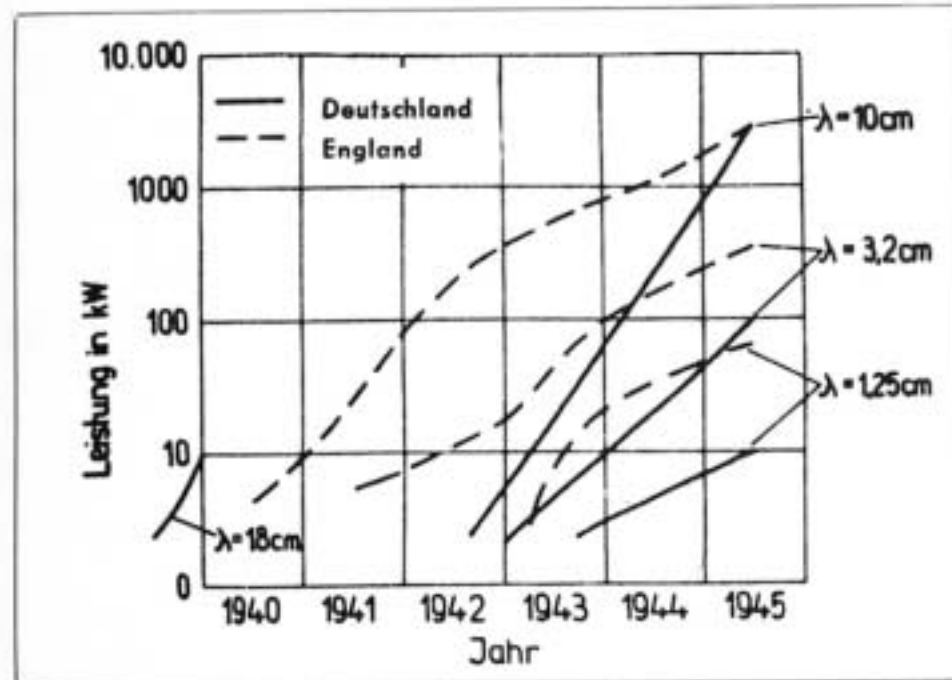

- Note the consistent lead which the British held throughout the war. The Germans started so late that they never caught up except on 10 cm (3 GHz) – just at war's end.

Berlin A (FuG 224)

typical system component

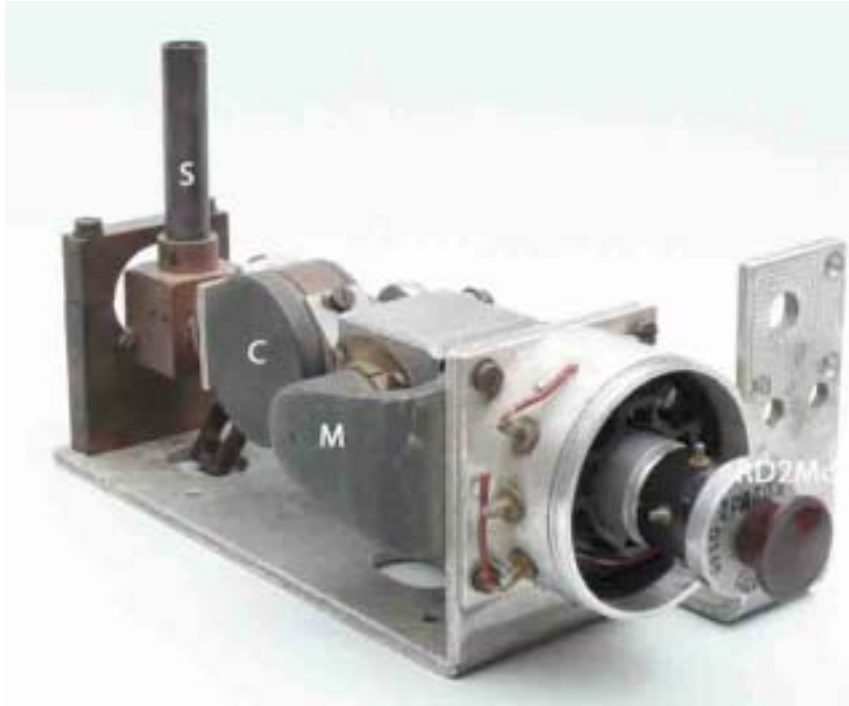

FuG 224 receiver local oscillator assembly

LO of Berlin FuG224 radar. The RD 2 Md split-anode magnetron has been partially pulled out of its socket. Note date code 0145. C = resonant tuned cavity; M is the permanent magnet, whose field traverses the split-anode inner space, parallel with the filament; S is a matching stub.

The actual front-end mixer fed by this LO signal was a point-contact silicon diode housed in the Berlin transmitter unit, very close to the antenna connector.

Note that the British H2S and US AN/APS-13 used a reflex-klystron LO. This technology was unavailable to the Germans until after WW2.

Acknowledgements

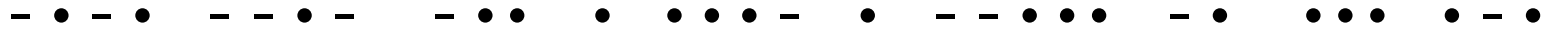

1. Foundation for German Communications
2. Fritz Trenkle (many images)
3. Jogi's Röhrenbude

Links for further study



- • — • — — • — — • • • — • — — • • • — • • • • • — •
- <http://www.radarworld.org/germany.html>
 - <http://www.skylighters.org/radar/index.html>
 - [Foundation for German Communications](#)
 - [Horst Beck Collection](#)
 - [FuG202/220 Lichtenstein airborne radars](#)
 - <http://www.gyges.dk/Himmelbett.htm>
 - [Aspects of German Airborne Radar, 1942-45](#)

Future Presentations on German WW2 RF Topics

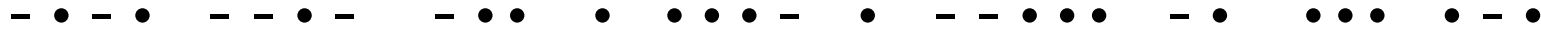

- **Radio Direction Finding:** Allied & German land, airborne & naval D/F, including British “Huff-Duff”
- **ECM:** Comms and radar jamming, ECCM