



NEW PRODUCT INFORMATION

HF/50MHz TRANSCEIVER

IC-7410



Icom proudly announces the debut of the new HF/50MHz transceiver IC-7410. The IC-7410 has been designed as an HF/50MHz specialized rig with excellent performance and features in this category. The appearance and operability of the IC-746PRO/7400 has been mostly retained to maintain the familiarity in usability from old to new. The IC-7410 employs high grade DSP unit and double conversion super-heterodyne system developed from the latest technology used in our higher grade rigs such IC-7800/7700/7600 series. In addition, the IC-7410 comes with a built-in 15kHz 1st IF filter and can accept up to two optional filters (3kHz/6kHz). When used with these 1st IF filters, narrow mode signals such as the CW and SSB modes are protected from adjacent strong signals.

MAJOR SELLING POINTS

- +30dBm 3rd order intercept point (in 14MHz band)**
- Double conversion superheterodyne system improves inband IMD characteristics**
- 32-bit floating point DSP unit**
- Built-in 15kHz first IF filter and optional 3kHz and 6kHz first IF filters**
- Large monochrome LCD display**
- ± 0.5 ppm frequency stability**
- Built-in simple band scope**
- Built-in automatic antenna tuner**
- All mode (SSB/CW/RTTY/AM/FM)**
- Optional RS-BA1 for IP remote control**

FEATURES

Faster DSP unit and in-house DSP expertise

The IC-7410 employs a much higher speed DSP unit compared to the IC-746PRO/7400's DSP unit. The AD/DA converter AK4620B allows for a high dynamic range and superior S/N ratio.

The Icom in-house DSP expertise is the result of more than ten years accumulated technical know-hows. We know how to bring out the best performance of the DSP and various digital functions.

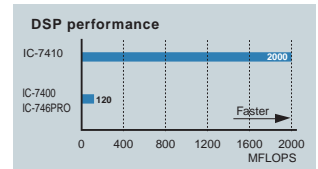

<DSP unit>
 ADSP-21369
 Internal clock speed: 333MHz
 32-bit floating point DSP
 Max. performance: 2000MFLOPS



<AD/DA converter>
 AK4620B
 ADC Signal/(Noise+Distortion) : 100dB
 ADC Dynamic range, S/N : 113dB
 DAC Signal/(Noise+Distortion) : 97dB
 DAC Dynamic range, S/N : 115dB

Double-conversion superheterodyne dramatically improves inband IMD

The IC-7410 employs a double conversion superheterodyne system which has an image rejection mixer for the 2nd mixer stage. When compared to a typical triple-conversion system, the double-conversion system dramatically reduces signal distortion and provides a high-fidelity RF signal to the DSP processor.

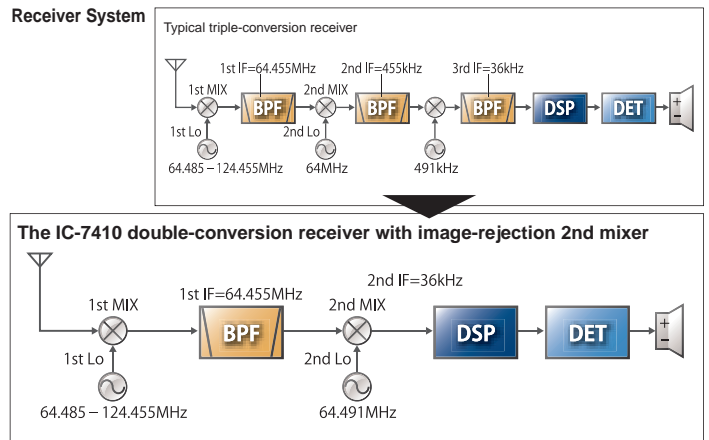

+30dBm third-order intercept point (IP3) in 14MHz

Icom's analog RF circuit experience over a number of years combined with the latest DSP software technology results in +30dBm IP3 equivalent to the IC-7600. Even in tough RF conditions, such as interference by broadcast stations or strong neighbouring ham stations, a weak signal can be clearly received by the IC-7410.

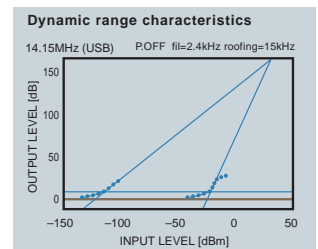

Three first IF filters (3/6/15kHz)

The IC-7410 comes with a built-in 15kHz 1st IF filter and can accept up to two optional filters (3kHz FL-431 and 6kHz FL-430). By changing the first IF filter width according to the operating mode, the desired signal is protected from the influence of nearby strong stations. The 3kHz first IF filter is especially effective in the CW and SSB modes. (Fixed for 15kHz in FM mode.)

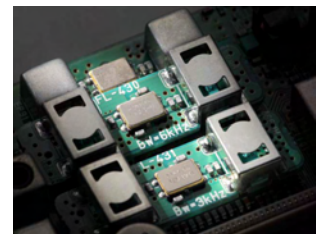

High frequency stability

A high stability TCXO crystal oscillator provides ± 0.5 ppm of high frequency stability over a wide temperature range (0°C to +50°C). This allows for a long stable operating time in modes such as RTTY.

FEATURES

Large, Multi-function LCD

The display increases in width from the IC-746PRO/7400. The large multi-function LCD shows frequency, 9-character channel name, channel number, multi functional meter (includes S-meter, RF output, SWR and ALC level). The dot-matrix portion of the LCD shows the following items:

- Channel name
- Function key assignment
- Band scope
- RTTY decoder screen
- Memory keyer contents
- Graphical SWR scale

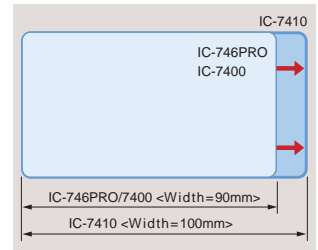

Simple band scope

The built-in simple band scope shows the band condition at a glance and is handy for searching for active stations.

RTTY demodulator and decoder

The built-in RTTY demodulator and decoder allow you to instantly read an RTTY message on the display. No external units or PC required. The built-in tuning indicator visually helps in critical tuning.

Ample CW functions

All of the following CW capabilities are included in the IC-7410:

- Large CW PITCH knob and independent BK-IN (break-in) delay knob improve operating efficiency
- CW wave form controlled by the DSP
- 4 keyer channels with 70 characters of transmit memory per channel
- Multi-function electronic keyer with adjustable keying speed from 6–48 wpm, dot-dash ratio from 1:1:2.8 to 1:1:4.5 and paddle polarity
- Bug keyer and full break-in function
- Continuously adjustable CW pitch control from 300–900Hz
- Double key jacks (Front and rear panels) • CW reverse

Built-in antenna tuner

The internal antenna tuner covers from 1.9MHz to 50MHz and automatically tunes for low SWR. Variable capacitors provide higher accuracy than a typical mechanical relay tuner. Once you transmit on a frequency, the tuner can instantly retune the frequency using its built-in memory.

USB connector for PC control

The IC-7410 has a standard type B USB connector and can be connected to a PC. Modulation input, audio output, RTTY demodulator output and CI-V command can be controlled via the USB cable. Also, the conventional CI-V remote control jack is built in to the IC-7410.



Large heat sink

When compared to the IC-746PRO/7400, the IC-7410's large heat sink improves heat dissipation. Even during long hours of heavy-duty cycle operation, the IC-7410 provides stable output power.

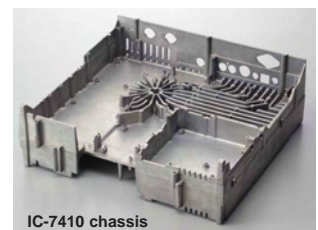

Optional RS-BA1 IP remote control software

The optional RS-BA1 allows you to use the IC-7410 from another room using your home network or even from a remote location over the Internet. Most settings such as filter width, AGC constant, etc, can be controlled from your PC.

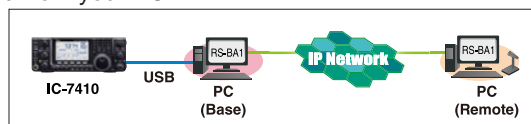

FEATURES

Other outstanding features

- Built-in voice synthesizer announces operating frequency, mode and S-meter level
- User programmable band edge beep (Can be disabled)
- VSC (Voice Squelch Control) function
- RF speech compressor
- Microphone equalizer and adjustable transmit bandwidth
- Two preamplifier types: Preamp 1: Increases low level signal improving intermodulation characteristics, Preamp 2: High gain preamplifier
- 20dB built-in attenuator
- Audio equalizer function
- CTCSS and DTCS tone encoder and decoder
- Triple band stacking register
- Quick split function and frequency lock function
- RIT and Δ Tx variable up to ± 9.999 kHz
- SSB/CW synchronous tuning automatically shifts the carrier point when switching between CW and LSB/USB modes
- 1Hz pitch tuning and display
- Program scan, memory scan, select memory scan, mode select scan and Δ f scan
- Automatic tuning steps
- AH-4 control circuit
- Large independent MIC/RF power and Notch knobs

REAR PANEL

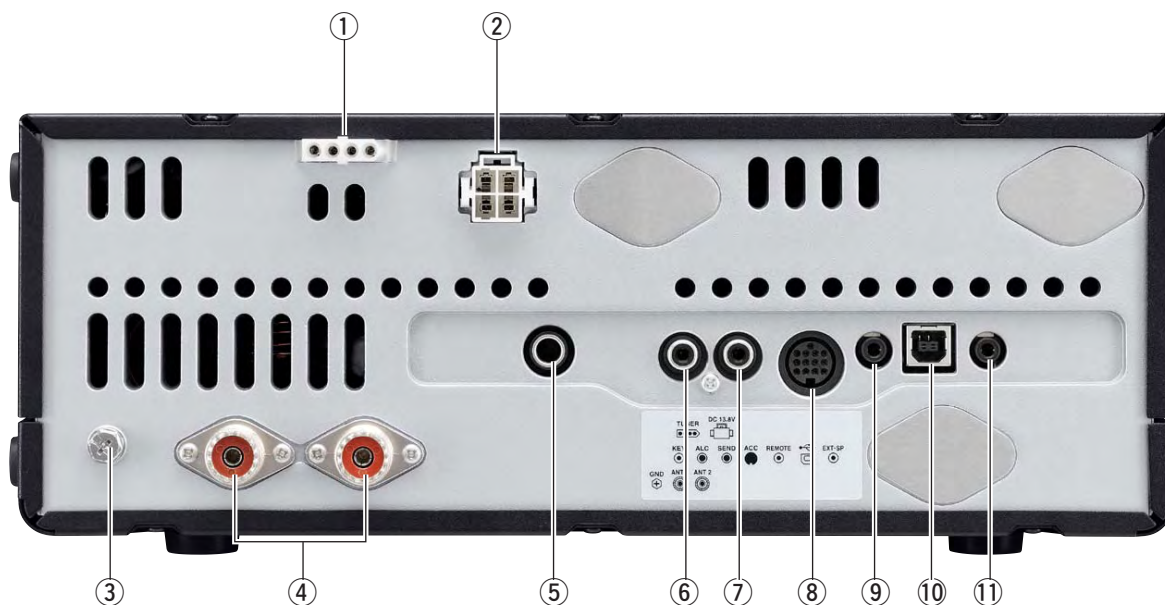

- | | | |
|----------------------|---------------------|----------------------------|
| ① Tuner Socket | ⑤ Key Jack | ⑨ CI-V Remote Control Jack |
| ② DC Power Socket | ⑥ ALC Input Jack | ⑩ USB Connector |
| ③ Ground Terminal | ⑦ Send Control Jack | ⑪ External Speaker Jack |
| ④ Antenna Connectors | ⑧ Accessory Socket | |

SPECIFICATIONS

Specifications described below are target values. They may be subject to change.

■ GENERAL

• Frequency range*1	:	
USA version (#02)		
Rx	0.030–60.000MHz*2	
Tx	1.800– 1.999MHz	3.500– 3.999MHz
	5.255– 5.405MHz*2	7.000– 7.300MHz
	10.100–10.150MHz	14.000–14.350MHz
	18.068–18.168MHz	21.000–21.450MHz
	24.890–24.990MHz	28.000–29.700MHz
	50.000–54.000MHz	
Europe version (#03), Europe-1 version (#04)		
Rx	0.030–60.000MHz*2	
Tx	1.810– 1.999MHz	3.500– 3.800MHz
	7.000– 7.100MHz (EUR version)	
	7.000– 7.200MHz (EUR-1 version)	
	10.100–10.150MHz	14.000–14.350MHz
	18.068–18.168MHz	21.000–21.450MHz
	24.890–24.990MHz	28.000–29.700MHz
	50.000–52.000MHz	

*1 Frequency coverage depends on version.

*2 Some frequency bands are not guaranteed.

• Mode	:	USB, LSB, CW, RTTY (FSK), FM, AM
• No. of memory channels	:	101 Ch (99 regular Ch, 2 scan edges)
• Power supply requirement	:	13.8V DC \pm 15 %
• Operating temp. range	:	0°C to +50°C; +32°F to +122°F
• Frequency stability	:	Less than \pm 0.5ppm (0°C to +50°C)
• Current drain (at 13.8V DC)	:	
Transmit	Max. power	23A
Receive	Max. audio	3.0A
	Stand-by	2.2A
• Antenna connector	:	SO-239 (50 Ω) \times 2
• Dimensions (W \times H \times D) (projections not included)	:	315 \times 116 \times 343 mm 12.4 \times 4.57 \times 13.5 in
• Weight (approx.)	:	10.2kg; 22.5lb

■ TRANSMITTER

• Modulation system	:	
SSB		Digital PSN modulation
AM		Digital low power modulation
FM		Digital phase modulation
• Output power	:	
SSB, CW, RTTY, FM		2–100W
AM		2–27W
• Spurious emissions (Unwanted emission)	:	
1.8–29.995MHz		Less than –50dB
50MHz		Less than –63dB
• Carrier suppression	:	More than 40dB
• Unwanted sideband	:	More than 55dB
• Microphone connector	:	8-pin connector (600 Ω)

■ RECEIVER

• Intermediate frequencies	:	64.455MHz, 36kHz
• Sensitivity	:	
SSB, CW (10dB S/N)		
1.8–29.999MHz		0.16 μ V typ.*3
50MHz		0.13 μ V typ.*4
AM (10dB S/N)		
0.5–1.799MHz		12.6 μ V typ.*3
1.8–29.999MHz		2.0 μ V typ.*3
50MHz		1.6 μ V typ.*4
FM (12dB SINAD)		
28–29.7MHz		0.50 μ V typ.*3
50MHz		0.32 μ V typ.*4
		*3 Preamp 1 ON *4 Preamp 2 ON
• Squelch sensitivity (preamp: ON, threshold):		
FM		Less than 0.3 μ V
SSB		Less than 5.6 μ V
• Selectivity	:	
SSB		More than 2.4kHz/–6dB
(BW: 2.4kHz, sharp)		Less than 3.4kHz/–40dB
CW		More than 500Hz/–6dB
(BW: 500Hz, sharp)		Less than 700Hz/–40dB
RTTY (BW: 350Hz sharp)		More than 500Hz/–6dB
		Less than 800Hz/–40dB
AM (BW: 6kHz)		More than 6.0kHz/–6dB
		Less than 10.0kHz/–40dB
FM (BW: 15kHz)		More than 12.0kHz/–6dB
		Less than 22.0kHz/–40dB
• Spurious and image rejection	:	More than 70dB
• Audio output power	:	More than 2.0W at 10% distortion with an 8 Ω load
• External SP connector	:	2-conductor 3.5 (d) mm (1/4") /8 Ω
• RIT variable range	:	\pm 9.999kHz
• PHONES connector	:	3-conductor 3.5 (d) mm (1/8")

■ ANTENNA TUNER

• Matching range	:	
HF bands		16.7 Ω to 150 Ω unbalanced*1
50MHz band		20 Ω to 125 Ω unbalanced*2
		*1 VSWR : Less than 1:3 *2 VSWR Less than 1:2.5
• Minimum operating power	:	
HF bands		8W
50MHz band		15W
• Tuning quality	:	VSWR Less than 1:1.5 (Motor stopped)
• Insertion loss	1.8MHz	Less than 1.2dB
	Other band (except for 1.8MHz)	Less than 1.0dB (Matched at 100W output)

OPTIONS

■ HAND MICROPHONE

HM-36 : Same as supplied with the radio.

■ DESKTOP MICROPHONE

SM-30 : Compact, lightweight electret microphone with low cut function.

SM-50 : Dynamic microphone. Includes [UP]/[DOWN] switches and low cut function.

■ EXTERNAL SPEAKERS

SP-21 : 132×111×287 mm (W×H×D, projections not included) Max. input 5W, 8Ω

SP-23 : 145×111×282.5 mm (W×H×D, projections not included) Max. input 5W, 8Ω

■ DC POWER SUPPLY

PS-126 : Output: 13.8V DC, 25A max. 94×111×287 mm (W×H×D, projections not included)

■ HF+50 MHz AUTOMATIC ANTENNA TUNER

AH-4 : Covers 3.5–50 MHz with a 7 m (23 ft) or longer wire antenna.

■ ANTENNA ELEMENT

AH-2b : 2.5m mobile antenna element for use with AH-4. 7–30 MHz can be tuned.

■ 1st IF FILTERS

FL-430 : 6kHz 1st IF filter for HF/50MHz band.

FL-431 : 3kHz 1st IF filter for HF/50MHz band.

■ CI-V LEVEL CONVERTER

CT-17 : For remote transceiver control from a PC equipped with an RS-232C port.

■ IP REMOTE CONTROL SOFTWARE

RS-BA1 : For IP remote transceiver control from a PC.

■ HF+50 MHz 1 kW HF LINEAR AMPLIFIER

IC-PW1/EURO : Covers all HF and 50 MHz bands, provides 1 kW output. Automatic antenna tuner and compact detachable controller are standard. 2 exciter inputs are available.

■ CABLE ADAPTER

OPC-599 : Converts 13-pin ACC connector to 7-pin + 8-pin ACC connector for connection with IC-PW1/EURO.

■ CARRYING HANDLE

MB-123 : Same as supplied with the radio.



SM-30

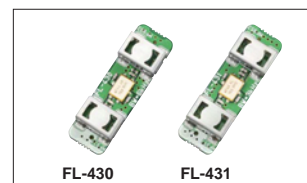

FL-430

FL-431



RS-BA1 screen example

Icom, Icom Inc. and the Icom logo are registered trademarks of Icom Incorporated (Japan) in the United States, the United Kingdom, Germany, France, Spain, Russia, Japan and/or other countries. All other trademarks are the properties of their respective holders.